



User Manual

ARK-1123

Fanless Embedded Box PC

ADVANTECH

Enabling an Intelligent Planet

Attention!

This package contains a hard-copy user manual in Chinese for China CCC certification purposes, and there is an English user manual included as a PDF file on the CD. Please disregard the printed Chinese copy of the user manual if the product is not to be sold and/or installed in China.

Copyright

The documentation and the software included with this product are copyrighted 2014 by Advantech Co., Ltd. All rights are reserved. Advantech Co., Ltd. reserves the right to make improvements in the products described in this manual at any time without notice. No part of this manual may be reproduced, copied, translated or transmitted in any form or by any means without the prior written permission of Advantech Co., Ltd. Information provided in this manual is intended to be accurate and reliable. However, Advantech Co., Ltd. assumes no responsibility for its use, nor for any infringements of the rights of third parties, which may result from its use.

Acknowledgements

Award is a trademark of Award Software International, Inc.

VIA is a trademark of VIA Technologies, Inc.

IBM, PC/AT, PS/2 and VGA are trademarks of International Business Machines Corporation.

Intel® and Pentium® are trademarks of Intel Corporation.

Microsoft Windows® is a registered trademark of Microsoft Corp.

RTL is a trademark of Realtek Semi-Conductor Co., Ltd.

ESS is a trademark of ESS Technology, Inc.

UMC is a trademark of United Microelectronics Corporation.

SMI is a trademark of Silicon Motion, Inc.

Creative is a trademark of Creative Technology LTD.

CHRONTEL is a trademark of Chrontel Inc.

All other product names or trademarks are properties of their respective owners.

For more information about this and other Advantech products, please visit our website at:

<http://www.advantech.com/>

<http://www.advantech.com/ePlatform/>

For technical support and service, please visit our support website at:

<http://support.advantech.com.tw/support/>

Product Warranty (2 years)

Advantech warrants to you, the original purchaser, that each of its products will be free from defects in materials and workmanship for two years from the date of purchase.

This warranty does not apply to any products which have been repaired or altered by persons other than repair personnel authorized by Advantech, or which have been subject to misuse, abuse, accident or improper installation. Advantech assumes no liability under the terms of this warranty as a consequence of such events.

Because of Advantech's high quality-control standards and rigorous testing, most of our customers never need to use our repair service. If an Advantech product is defective, it will be repaired or replaced at no charge during the warranty period. For out-of-warranty repairs, you will be billed according to the cost of replacement materials, service time and freight. Please consult your dealer for more details.

If you think you have a defective product, follow these steps:

1. Collect all the information about the problem encountered. (For example, CPU speed, Advantech products used, other hardware and software used, etc.) Note anything abnormal and list any onscreen messages you get when the problem occurs.
2. Call your dealer and describe the problem. Please have your manual, product, and any helpful information readily available.
3. If your product is diagnosed as defective, obtain an RMA (return merchandise authorization) number from your dealer. This allows us to process your return more quickly.
4. Carefully pack the defective product, a fully-completed Repair and Replacement Order Card and a photocopy proof of purchase date (such as your sales receipt) in a shippable container. A product returned without proof of the purchase date is not eligible for warranty service.
5. Write the RMA number visibly on the outside of the package and ship it prepaid to your dealer.

Declaration of Conformity

FCC Class A

Note: This equipment has been tested and found to comply with the limits for a Class A digital device, pursuant to part 15 of the FCC Rules. These limits are designed to provide reasonable protection against harmful interference when the equipment is operated in a commercial environment. This equipment generates, uses, and can radiate radio frequency energy and, if not installed and used in accordance with the instruction manual, may cause harmful interference to radio communications. Operation of this equipment in a residential area is likely to cause harmful interference in which case the user will be required to correct the interference at his own expense.

Technical Support and Assistance

1. Visit the Advantech web site at www.advantech.com/support where you can find the latest information about the product.
2. Contact your distributor, sales representative, or Advantech's customer service center for technical support if you need additional assistance. Please have the following information ready before you call:
 - Product name and serial number
 - Description of your peripheral attachments
 - Description of your software (operating system, version, application software, etc.)
 - A complete description of the problem
 - The exact wording of any error messages

Warnings, Cautions and Notes

Warning! *Warnings indicate conditions, which if not observed, can cause personal injury!*



Caution! *Cautions are included to help you avoid damaging hardware or losing data.*



Note! *Notes provide optional additional information.*



Safety Instructions

1. Read these safety instructions carefully.
2. Keep this User Manual for later reference.
3. Disconnect this equipment from any AC outlet before cleaning. Use a damp cloth. Do not use liquid or spray detergents for cleaning.
4. For plug-in equipment, the power outlet socket must be located near the equipment and must be easily accessible.
5. Keep this equipment away from humidity.
6. Put this equipment on a reliable surface during installation. Dropping it or letting it fall may cause damage.
7. The openings on the enclosure are for air convection. Protect the equipment from overheating. **DO NOT COVER THE OPENINGS.**
8. Make sure the voltage of the power source is correct before connecting the equipment to the power outlet.
9. Position the power cord so that people cannot step on it. Do not place anything over the power cord.
10. All cautions and warnings on the equipment should be noted.
11. If the equipment is not used for a long time, disconnect it from the power source to avoid damage by transient overvoltage.
12. Never pour any liquid into an opening. This may cause fire or electrical shock.
13. Never open the equipment. For safety reasons, the equipment should be opened only by qualified service personnel.
14. If one of the following situations arises, get the equipment checked by service personnel:
 - The power cord or plug is damaged.
 - Liquid has penetrated into the equipment.
 - The equipment has been exposed to moisture.
 - The equipment does not work well, or you cannot get it to work according to the user's manual.
 - The equipment has been dropped and damaged.
 - The equipment has obvious signs of breakage.
15. **DO NOT LEAVE THIS EQUIPMENT IN AN ENVIRONMENT WHERE THE STORAGE TEMPERATURE MAY GO BELOW -20° C (-4° F) OR ABOVE 60° C (140° F). THIS COULD DAMAGE THE EQUIPMENT. THE EQUIPMENT SHOULD BE IN A CONTROLLED ENVIRONMENT.**
16. **CAUTION: DANGER OF EXPLOSION IF BATTERY IS INCORRECTLY REPLACED. REPLACE ONLY WITH THE SAME OR EQUIVALENT TYPE RECOMMENDED BY THE MANUFACTURER, DISCARD USED BATTERIES ACCORDING TO THE MANUFACTURER'S INSTRUCTIONS.**
17. **CAUTION:** Any unverified component could cause unexpected damage. To ensure the correct installation, please always use the components (ex. screws) provided with the accessory box.

ATTENTION: Tout composant non vérifié pourrait causer des dommages inattendu. Pour garantir une installation correcte, s'il vous plaît utilisez toujours les composants (vis ex.) fournies avec la boîte d'accessoires.
18. **CAUTION:** The computer is provided with a battery-powered real-time clock circuit. There is a danger of explosion if battery is incorrectly replaced. Replace only with same or equivalent type recommended by the manufacture. Discard used batteries according to the manufacturers instructions.

ATTENTION: L'ordinateur est muni d'un circuit en temps réel de l'horloge alimentée par batterie. Il ya un danger d'explosion si la pile est remplacée de

façon incorrecte. Remplacez uniquement par un type identique ou équivalent vii ARK-1123 User Manual recommandé par le fabricant. Jetez les piles usag

19. CAUTION: Always completely disconnect the power cord from your chassis whenever you work with the hardware. Do not make connections while the power is on. Sensitive electronic components can be damaged by sudden power surges.

ATTENTION: Toujours débrancher complètement le cordon d'alimentation de votre châssis lorsque vous travaillez avec le matériel. Ne pas effectuer les raccordements lorsque l'appareil est sur. Composants électroniques sensibles peuvent être endommagés par les surtensions soudaines.

The sound pressure level at the operator's position according to IEC 704-1:1982 is no more than 70 dB (A).

DISCLAIMER: This set of instructions is given according to IEC 704-1. Advantech disclaims all responsibility for the accuracy of any statements contained herein.

Packing list

Before installation, please ensure the following items have been shipped:

- 1 x ARK-1123 unit
- 1 x DC 12V Power Adapter (PN: 1757004096-01)
- 1 x Chinese user manual
- 1 x China RoHS
- 1 x 2-year warranty card

Ordering Information

Model Number	Description
ARK-1123H-U0A1E	Intel Celeron J1900 QC 2.0GHz w/dual HDMI + 2 GbE
ARK-1123C-S3A1E	Intel Atom E3825 DC 1.3GHz w/dual COM + 2 GbE
ARK-1123L-S3A1E	Intel Atom E3825 DC 1.3GHz w/dual COM + GbE + DIO

Optional Accessories

Part Number	Description
1700001524	Power Cable 3-pin 180cm, USA type (for Power adapter 1757004096-01)
170203183C	Power Cable 3-pin 180cm, Europe type (for Power adapter 1757004096-01)
170203180A	Power Cable 3-pin 180cm, UK type (for Power adapter 1757004096-01)
1700008921	Power Cable 3-pin PSE Mark 183cm (for Power adapter 1757004096-01)
1757004522-01	AC to DC wide temperature power adapter, DC 12V/3.33A 40W, -20~70C
1702002600-01	Power cord 3pin 183cm, USA type (for power adapter 1757004522-01)
1700018705	Power cord 3pin 183cm, Europe type (for power adapter 1757004522-01)
1700018704	Power cord 3pin 183cm, UK type (for power adapter 1757004522-01)
1700000237-01	Power cord 3pin 183cm, PSE type (for power adapter 1757004522-01)
AMK-V003E	ARK-112X series VESA mounting kit
AMK-W001E	ARK-112X series wall mounting kit
AMK-R001E	ARK-112X series DIN Rail mounting kit

Contents

Chapter 1	General Introduction	1
1.1	Introduction	2
1.2	Features	2
1.3	Specifications	2
1.3.1	General	2
1.3.2	Display	3
1.3.3	Ethernet	3
1.3.4	Power Consumption.....	3
1.3.5	Power Requirement	3
1.4	Environmental Specifications	3
1.5	Mechanical Specifications	4
1.5.1	ARK-1123H Dimensions	4
	Figure 1.1 ARK-1123H mechanical dimension drawing	4
1.5.2	ARK-1123C Dimensions	5
	Figure 1.2 ARK-1123C mechanical dimension drawing	5
1.5.3	ARK-1123L Dimensions.....	5
	Figure 1.3 ARK-1123L mechanical dimension drawing	5
Chapter 2	Hardware Installation	7
2.1	Jumpers	8
2.1.1	Jumper Description	8
2.1.2	Jumper list.....	8
	Table 2.1: Jumper List.....	8
2.1.3	Jumper Settings	8
	Table 2.2: J1: LCD Power/Auto Power on.....	8
2.2	ARK-1123 I/O Indication	9
	Figure 2.1 ARK-1123H front view	9
	Figure 2.2 ARK-1123H rear view.....	9
	Figure 2.3 ARK-1123C front view	10
	Figure 2.4 ARK-1123C rear view.....	10
	Figure 2.5 ARK-1123C front view	10
	Figure 2.6 ARK-1123C rear view.....	11
2.3	ARK-1123H External I/O Connectors.....	11
2.3.1	Power ON/OFF Button.....	11
	Figure 2.7 Power ON/OFF Button	11
2.3.2	Power Input Connector	11
	Figure 2.8 Power Input Connector.....	11
2.3.3	Ethernet Connector (LAN)	12
	Figure 2.9 Ethernet Connector	12
	Table 2.3: Ethernet Connector Pin Assignments.....	12
2.3.4	USB Connectors	13
	Figure 2.10USB Connector.....	13
	Table 2.4: USB Connector Pin Assignments.....	13
2.3.5	Audio Connector	13
	Figure 2.11Audio Connector.....	13
	Table 2.5: DIO Connector Pin Assignments.....	13
2.3.6	COM Connector	14
	Figure 2.12COM Port Connector	14
	Table 2.6: COM Connector Pin Assignments.....	14
2.3.7	HDMI Connector	14
	Figure 2.13HDMI Connector	14
	Table 2.7: HDMI / Display Port Connector Pin Assignments.....	15
2.3.8	HDD LED Indicator	15

2.4	ARK-1123C External I/O Connectors	15
2.4.1	Power ON/OFF Button.....	15
	Figure 2.14Power ON/OFF Button	15
2.4.2	Power Input Connector.....	16
	Figure 2.15Power Input Connector.....	16
2.4.3	Ethernet Connector (LAN).....	16
	Figure 2.16Ethernet Connector	16
	Table 2.8: Ethernet Connector Pin Assignments	16
2.4.4	VGA Connector.....	17
	Figure 2.17VGA Connector	17
	Table 2.9: VGA Connector Pin Assignments	17
2.4.5	USB Connectors.....	17
	Figure 2.18USB Connector	17
	Table 2.10: USB Connector Pin Assignments.....	18
2.4.6	Audio Connector.....	18
	Figure 2.19Audio Connector.....	18
	Table 2.11: Audio Connector Pin Assignments.....	18
2.4.7	COM Connector.....	18
	Figure 2.20COM Port Connector.....	18
	Table 2.12: COM Connector Pin Assignments.....	18
2.4.8	HDD LED Indicator	19
2.5	ARK-1123L External I/O Connectors	19
2.5.1	Power ON/OFF Button.....	19
	Figure 2.21Power ON/OFF Button	19
2.5.2	Power Input Connector.....	19
	Figure 2.22Power Input Connector.....	19
2.5.3	Ethernet Connector (LAN).....	20
	Figure 2.23Ethernet Connector	20
	Table 2.13: Ethernet Connector Pin Assignments	20
2.5.4	VGA Connector.....	20
	Figure 2.24VGA Connector	20
	Table 2.14: VGA Connector Pin Assignments	20
2.5.5	USB Connectors.....	21
	Figure 2.25USB Connector	21
	Table 2.15: USB Connector Pin Assignments.....	21
2.5.6	Audio Connector.....	22
	Figure 2.26Audio Connector.....	22
	Table 2.16: Audio Connector Pin Assignments.....	22
2.5.7	COM Connector.....	22
	Figure 2.27COM Port Connector.....	22
	Table 2.17: COM Connector Pin Assignments.....	22
2.5.8	DIO Connector.....	23
	Table 2.18: DIO Connector Pin Assignments.....	23
2.5.9	HDD LED Indicator	23
2.6	Peripheral Installation	24
2.6.1	HDD Installation.....	24
2.6.2	mSATA HD Installation.....	26
2.6.3	RAM Installation.....	27

Chapter 3 BIOS Settings 29

3.1	BIOS Setup.....	30
3.2	Entering Setup.....	31
3.2.1	Main Setup.....	31
3.2.2	Advanced BIOS Features Setup.....	32
3.2.3	Chipset Configuration	45
3.2.4	Security.....	54
3.2.5	Boot	55
3.2.6	Save & Exit	56

Appendix A	WDT & GPIO Sample Code	57
A.1	Watchdog Timer Sample Code	58

Chapter 1

General Introduction

This chapter gives background information on ARK-1123.

1.1 Introduction

The ARK-1123 fanless Embedded Box Computer is an ideal, application-ready system solution. All electronics are protected in a compact, sealed, aluminum case for easy embedding in the customer's own housing, or as a stand-alone application where space is limited and the environment harsh. The solid, sealed aluminum case offers vibration and dust resistance while also providing a passive cooling solution. The ARK-1123 provides system integrators with a turn-key solution and versatile application development path without breaking the bank or missing time-to-market deadlines.

ARK-1123 is designed as a palm-size fanless embedded system and occupies only 133.8 x 43.1 x 94.2 mm (5.27" x 1.70" x 3.71"). The rugged, cast aluminum case not only provides great protection from EMI, shock/vibration, cold and heat, but also passive cooling for quiet, reliable operation. ARK-1123 meets demands by offering up to 2 x HDMI, 1 x VGA, 2 x GbE LAN, 3 x USB 2.0 ports, and 2 x COM ports; all packed into a compact rugged unit and powered by an Intel Celeron J1900 QC 2.0GHz / E3825 DC 1.3GHz processor. ARK-1123 also supports both 2.5" SATA HDD, mSATA and SSD for storage options even though it is a palm-size system. Besides, ARK-1123 is a low-power-consumption system and it is powered by DC 12 V input. The ARK-1123 provides for diversified application fields.

1.2 Features

Key features

- Extremely compact, sealed construction with fanless operation, supports Intel® Celeron J1900 QC 2.0GHz / Atom E3825 DC 1.3GHz SoC Processor
- Palm-size system with 2.5" SATA HDD/SSD/mSATA support
- Low power consumption system
- Support VESA/desk/DIN-rail mountings

1.3 Specifications

1.3.1 General

- **CPU:**
 - Intel® Celeron J1900 QC 2.0GHz SoC Processor (ARK-1123H)
 - Intel® Atom™ E3825 DC 1.3GHz SoC Processor (ARK-1123C/L)
- **BIOS:** AMI 64 Mbit Flash BIOS
- **System Memory:**
 - Up to 8G DDR3L 1333MHz SODIMM (ARK-1123H)
 - Up to 8G DDR3L 1066MHz SODIMM (ARK-1123C/L)
- **Watchdog Timer:** 255-level interval timer, setup by software
- **Serial Ports:**
 - 1 x RS-232/422/485 (BIOS selectable, ARK-1123H)
 - 2 x RS-232/422/485 (BIOS selectable, ARK-1123C)
 - 1 x RS-232 & 1 x RS-232/422/485 (BIOS selectable, ARK-1123L)
- **USB:**
 - 2 x USB 2.0 & 1 x USB 3.0 (ARK-1123H/C)
 - 1 x USB 2.0 & 1 x USB 3.0 (ARK-1123L)
- **Audio:** ALC-888S, High Definition Audio. Line-out & Line-in
- **Expansion Interface:** Support 2 x half size Mini-PCIe slot

- 1 x Full-size Mini PCIe, support WLAN or WWAN module
- 1 x Half-size Mini PCIe, support Half-size mSATA module

- **Storage:**

- Supports SSD or 1 x 2.5" SATAIII HDD 7 mm height only for ARK-1123C/L
- Supports H/S mSATA storage device (Suggest to assembly by CTOS or T-Part due to complex installation for ARK-1123H & C)
- DIO: 1 x DIO (ARK-1123L)

1.3.2 Display

- **Chipset:** Intel® Atom SoC integrated

- **Graphic Engine:**

- DirectX* 11.1, OGL 3.0, OCL 1.1, OGL ES 2.0
- Encode: H264, MPEG2/4, VC1, WMV9
- Decode: H264, MPEG2

- **VGA:** Supports up to 1920 x 1200 at 60 Hz (ARK-1123C/L)

** VGA does not support hot plug function due to Intel's constraint

- **HDMI:** Supports up to 1920 x 1080 at 60 Hz (ARK-1123H)

** HDMI does not support hot plug function due to Intel's constraint

** No audio function on HDMI 2 due to Intel's constraint

1.3.3 Ethernet

- **Chipset:** Intel I210

- **Speed:** 10/100/1000 Mbps, support Wake on LAN

- **Interface:** Up to 2 x RJ45 (ARK-1123H/C)

- **Standard:** Compliant with IEEE 802.3, IEEE 802.3u, IEEE 802.3x, IEEE 8023y, IEEE 802.ab.

1.3.4 Power Consumption

- **Input Voltage:** DC 12V

- **Power Adapter:** AC to DC, DC12 V/3 A, 36 W with lockable design

1.3.5 Power Requirement

- **Power Input:** Single DC 12V

- **RTC battery:** 3 V/210 mAh

1.4 Environmental Specifications

- **Operating temperature:**

- ARK-1123C/L: -30 ~ 70° C (With extended temperature SSD/mSATA devices) & 0 ~ 40° C (With standard temperature HDD/SSD/mSATA devices)
- ARK-1123H: -20 ~ 60° C (With extended temperature SSD/mSATA devices) & 0 ~ 40° C (With standard temperature HDD/SSD/mSATA devices)

- **Relative humidity:** 95% @ 40°C (non-condensing)

- **Storage temperature:** -40 ~ 85°C (-40 ~ 185°F)

- **Vibration loading during operation:**

- With mSATA/SSD: 3 Grms, IEC 60068-2-64, random, 5 ~ 500 Hz, 1 hr/axis
- With HDD: 0.5 Grms, IEC 60068-2-64, random, 5 ~ 500 Hz, 1 hr/axis

- **Shock during operation:**
 - With mSATA/SSD: 30 G, IEC 60068-2-27, half sine, 11 ms duration
 - With HDD: 10 G, IEC 60068-2-27, half sine, 11 ms duration
- **Safety:** UL,CB,CCC,BSMI
- **EMC:** CE, FCC Class A, BSMI, CCC

1.5 Mechanical Specifications

1.5.1 ARK-1123H Dimensions

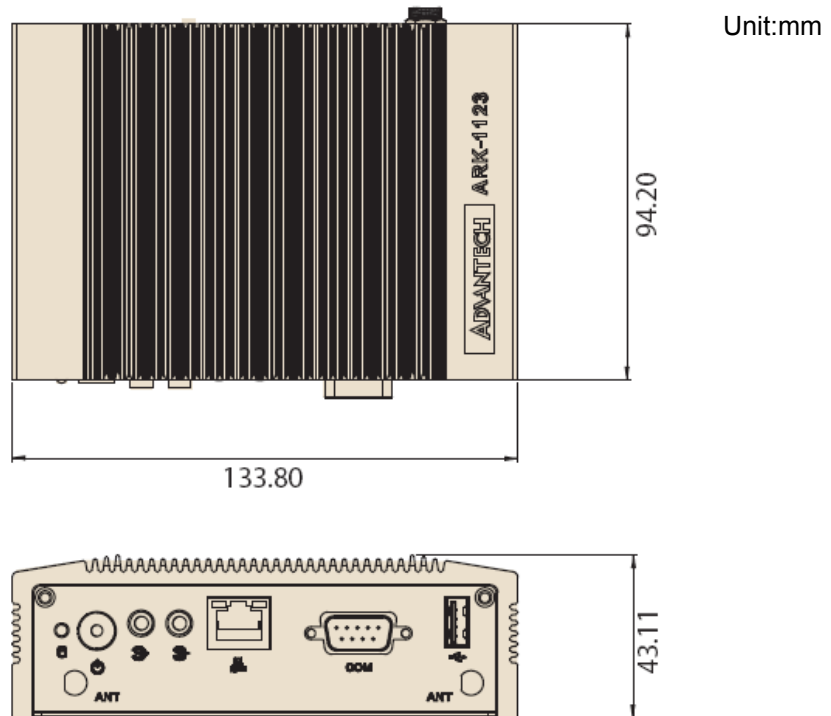

Figure 1.1 ARK-1123H mechanical dimension drawing

1.5.2 ARK-1123C Dimensions

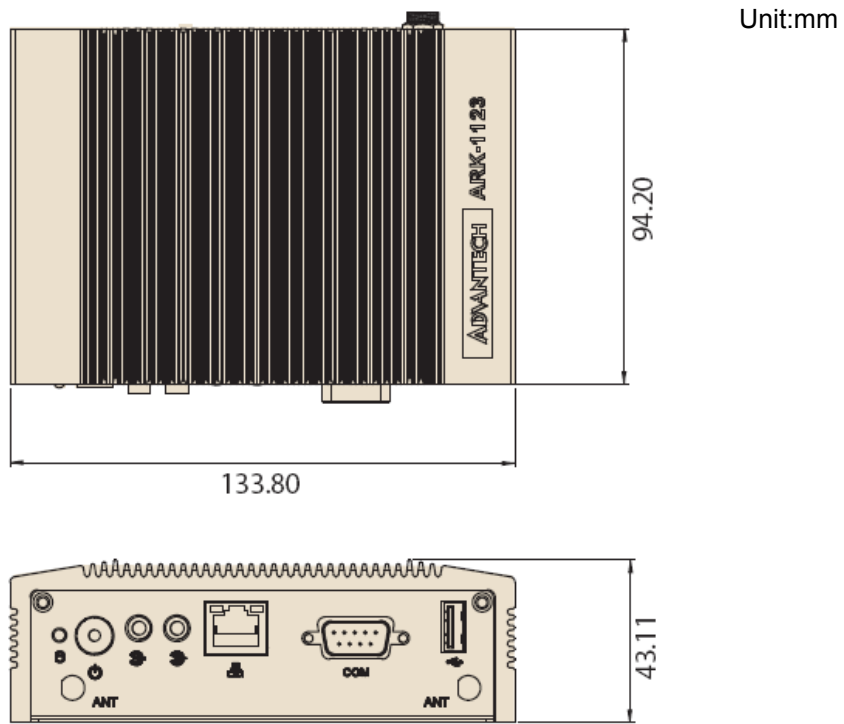

Figure 1.2 ARK-1123C mechanical dimension drawing

1.5.3 ARK-1123L Dimensions

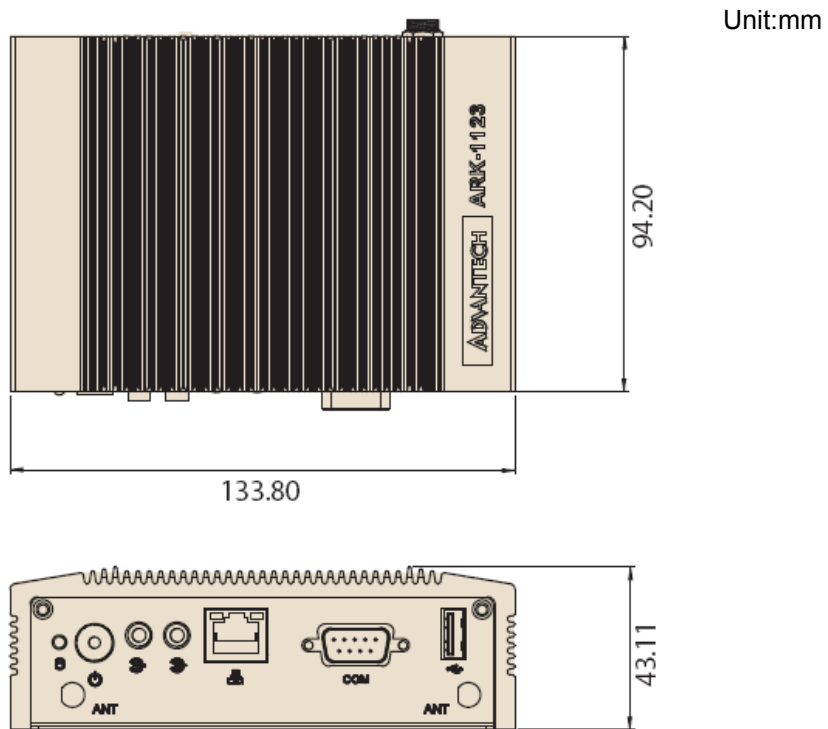

Figure 1.3 ARK-1123L mechanical dimension drawing

Chapter 2

Hardware Installation

This chapter introduces external IO and the installation of ARK-1123 Hardware.

2.1 Jumpers

2.1.1 Jumper Description

Cards can be configured by setting jumpers. A jumper is a metal bridge used to close an electric circuit. It consists of two metal pins and a small metal clip (often protected by a plastic cover) that slides over the pins to connect them. To close a jumper, you connect the pins with the clip. To open a jumper, you remove the clip. Sometimes a jumper will have three pins, labeled 1, 2 and 3. In this case you would connect either pins 1 and 2, or 2 and 3.

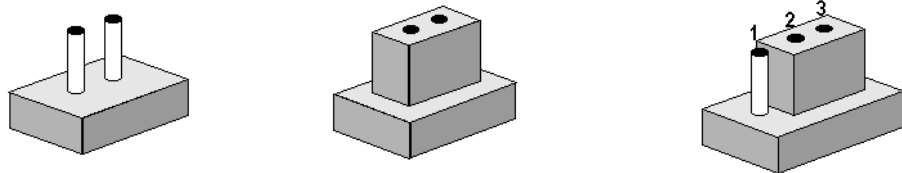

The jumper settings are schematically depicted in this manual as follows.



A pair of needle-nose pliers may be helpful when working with jumpers. If you have any doubts about the best hardware configuration for your application, contact your local distributor or sales representative before you make any changes.

Generally, you simply need a standard cable to make most connections.

Warning! To avoid damaging the computer, always turn off the power supply before setting jumpers or clearing CMOS. Before turning on the power supply, make sure CMOS jumper is back to 3.0 V Battery On.



2.1.2 Jumper list

Table 2.1: Jumper List

J1	LCD Power / Auto Power on
----	---------------------------

2.1.3 Jumper Settings

Table 2.2: J1: LCD Power/Auto Power on

Part Number	1653003260
Footprint	HD_3x2P_79
Description	PIN HEADER 3*2P 180D(M) 2.0mm SMD SQUARE PIN
Setting	Function
(1-2)	+5V
(3-4) (default)	+3.3V
(5-6)	Auto Power On

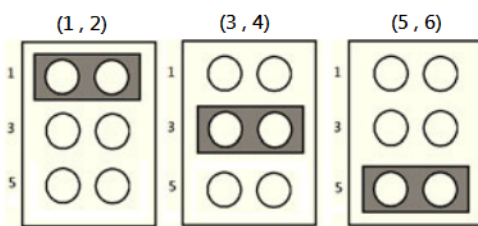

2.2 ARK-1123 I/O Indication

ARK-1123H

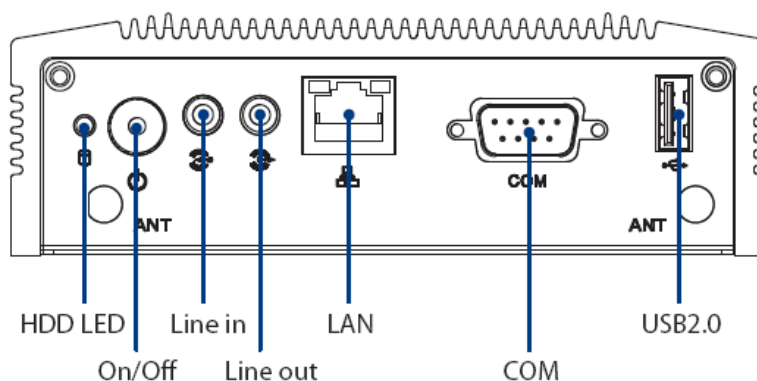
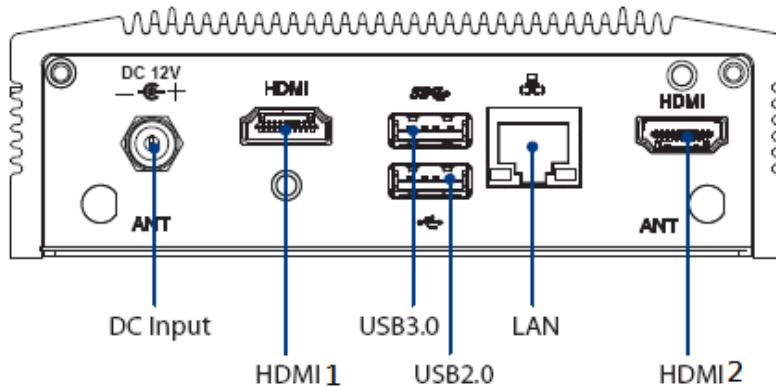

Figure 2.1 ARK-1123H front view



Note: HDMI do not support hot plug function due to Intel's constraint

Note: No Audio function in HDMI 2 due to Intel's constraint

Figure 2.2 ARK-1123H rear view

ARK-1123C

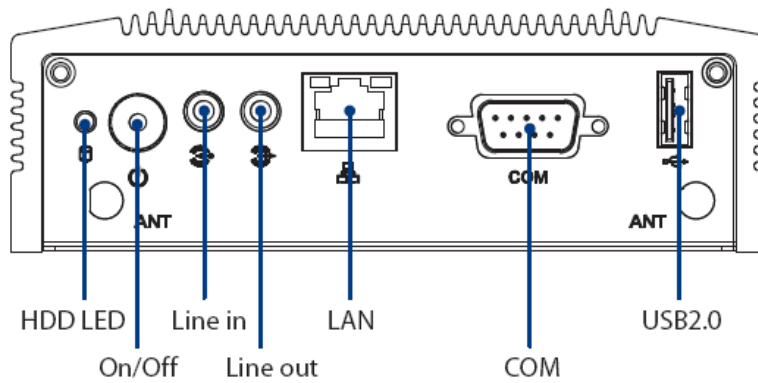
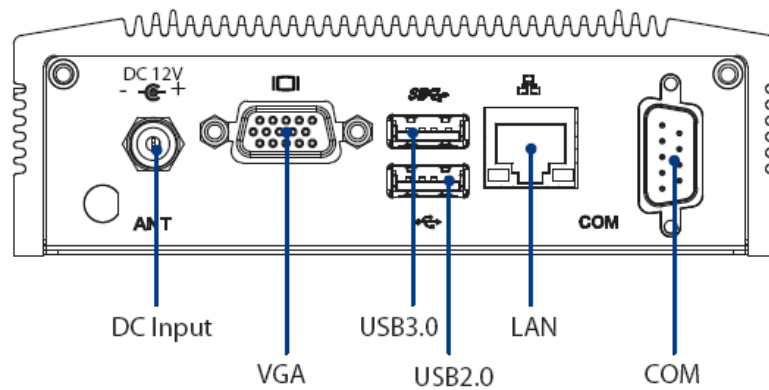

Figure 2.3 ARK-1123C front view



Note: VGA do not support hot plug function due to Intel's constraint

Figure 2.4 ARK-1123C rear view

ARK-1123L

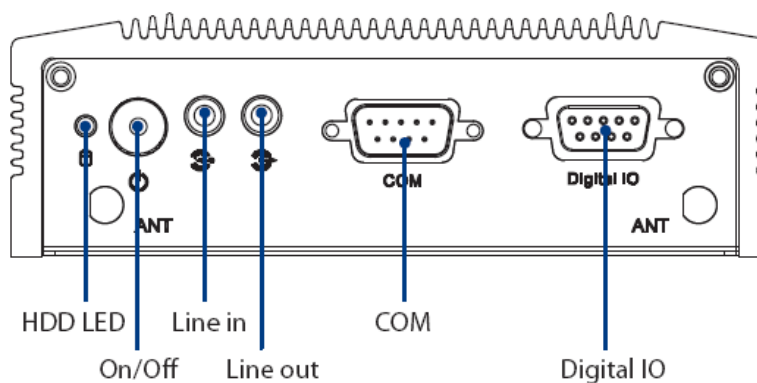
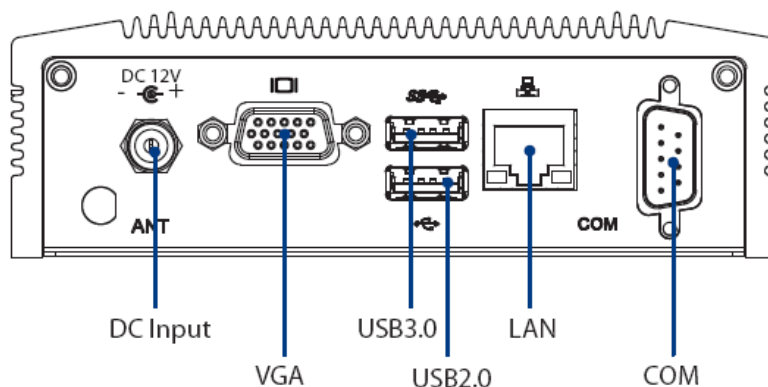

Figure 2.5 ARK-1123C front view



Note: VGA do not support hot plug function due to Intel's constraint

Figure 2.6 ARK-1123C rear view

2.3 ARK-1123H External I/O Connectors

2.3.1 Power ON/OFF Button

ARK-1123H comes with a Power On/Off button with LED indicators on the front side to show its On status (Green LED) and Off/Suspend status (Orange LED). Dual functions of Soft Power -On/Off (Instant off or Delay 4 Seconds), and Suspend are supported.



Figure 2.7 Power ON/OFF Button

2.3.2 Power Input Connector

ARK-1123H comes with a DC-Jack header that carries 12 V_{DC} external power input. The bracket makes the power connector very secure.

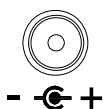

Figure 2.8 Power Input Connector

2.3.3 Ethernet Connector (LAN)

ARK-1123H provides two RJ45 LAN interface connector which is fully compliant with IEEE 802.3u 10/100/1000 Mbps CSMA/CD standards. It is equipped with Intel I210 and support Wake on LAN. The Ethernet port uses a standard RJ-45 jack connector with LED indicators on the front side to show Active/Link status and Speed status.

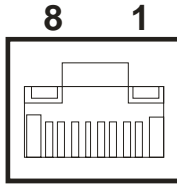

Figure 2.9 Ethernet Connector

Table 2.3: Ethernet Connector Pin Assignments	
Pin	10/100/1000 Mbps Signal Name
1	TX+, MDI0+
2	TX-, MDI0-
3	RX+, MDI1+
4	MDI2+
5	MDI2-
6	RX-, MDI1-
7	MDI3+
8	MDI3-

Note! NC, if present, means “No Connection”.



2.3.4 USB Connectors

The ARK-1123H provides three USB interface connectors - 2 x USB 2.0 & 1 x USB 3.0, which give complete Plug & Play. The USB interface is compliant with USB UHCI, Rev. 2.0 & 3.0. The USB interface supports Plug and Play, which enables you to connect or disconnect a device whenever you want, without turning off the computer.

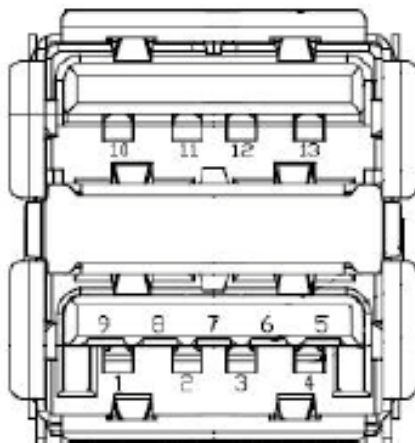

Figure 2.10 USB Connector

Table 2.4: USB Connector Pin Assignments

Pin	Signal Name	Pin	Signal Name
1	+5V	2	D-
3	D+	4	GND
5	SSRX-	6	SSRX+
7	GND	8	SSTX-
9	SSTX+	10	+5V
11	D-	12	D+
13	GND		

2.3.5 Audio Connector

ARK-1123H offers stereo audio ports by two 3.5 ear phone jack connectors of Line_out and Line_in. The audio chip controller is ALC-888S which is compliant with the Azalea standard.

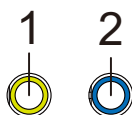

Figure 2.11 Audio Connector

Table 2.5: DIO Connector Pin Assignments

Pin	Signal Name
1	Line-out
2	Line-in

2.3.6 COM Connector

ARK-1123H provides one D-sub 9-pin connector, which offers RS-232/422/485 (BIOS Selectable) serial communication interface.

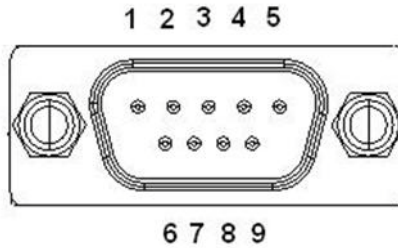

Figure 2.12 COM Port Connector

Table 2.6: COM Connector Pin Assignments

	RS-232	RS-422	RS-485
Pin	Signal Name	Signal Name	Signal Name
1	DCD	Tx-	DATA-
2	RxD	Tx+	DATA+
3	TxD	Rx+	NC
4	DTR	Rx-	NC
5	GND	GND	GND
6	DSR	NC	NC
7	RTS	NC	NC
8	CTS	NC	NC
9	RI	NC	NC

Note! NC means “No Connection”.



2.3.7 HDMI Connector

ARK-1123H provided two HDMI connectors. The HDMI link supports resolutions up to 1920 x 1080 @ 60 Hz.

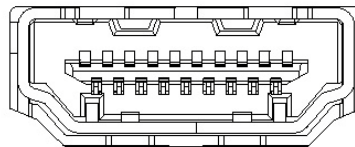

Figure 2.13 HDMI Connector

Table 2.7: HDMI / Display Port Connector Pin Assignments

Pin	Signal Name	Pin	Signal Name
1	TMDS_Data2+/ DP_Data0+	2	GND
3	TMDS_Data2-/ DP_Data0-	4	TMDS_Data1+/ DP_Data1+
5	GND	6	TMDS_Data1-/ DP_Data1-
7	TMDS_Data0+/ DP_Data2+	8	GND
9	TMDS_Data0-/ DP_Data2-	10	TMDS_Clock+/ DP_Data3+
11	GND	12	TMDS_Clock-/ DP_Data3-
13	NC	14	NC
15	SCL/ AUX_CH+	16	SDA/ GND
17	DDC GND/ AUX_CH-	18	+5V/ Hot plug detect
19	Hot plug detect/ Return	20	DP_PWR

Note! HDMI does not support hot plug function due to Intel's constraint



Note! No audio function in HDMI 2 due to Intel's constraint



2.3.8 HDD LED Indicator

HDD LED indicator on ARK-1123H front metal face plate for indicating system status: HDD LED is for HDD flash disk status.



2.4 ARK-1123C External I/O Connectors

2.4.1 Power ON/OFF Button

ARK-1123C comes with a Power On/Off button with LED indicators on the front side to show its On status (Green LED) and Off/Suspend status (Orange LED). Dual functions of Soft Power -On/Off (Instant off or Delay 4 Seconds), and Suspend are supported.



Figure 2.14 Power ON/OFF Button

2.4.2 Power Input Connector

ARK-1123C comes with a DC-Jack header that carries 12 V_{DC} external power input.

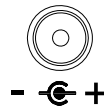

Figure 2.15 Power Input Connector

2.4.3 Ethernet Connector (LAN)

ARK-1123C provides two RJ45 LAN interface connectors which are fully compliant with IEEE 802.3u 10/100/1000 Mbps CSMA/CD standards. It is equipped with Intel I210 and support Wake on LAN. The Ethernet port uses a standard RJ-45 jack connector with LED indicators on the front side to show Active/Link status and Speed status.

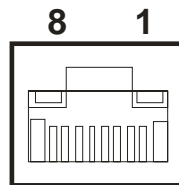

Figure 2.16 Ethernet Connector

Table 2.8: Ethernet Connector Pin Assignments	
Pin	10/100/1000 Mbps Signal Name
1	TX+, MDI0+
2	TX-, MDI0-
3	RX+, MDI1+
4	MDI2+
5	MDI2-
6	RX-, MDI1-
7	MDI3+
8	MDI3-

Note! NC, if present, means “No Connection”.



2.4.4 VGA Connector

The ARK-1123C provides a high resolution VGA interface connected by a D-sub 15-pin connector to support a VGA CRT monitor. It supports display resolution up to 1920 x 1080.

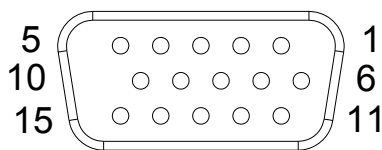

Figure 2.17 VGA Connector

Table 2.9: VGA Connector Pin Assignments			
Pin	Signal Name	Pin	Signal Name
1	Red	2	Green
3	Blue	4	NC
5	GND	6	GND
7	GND	8	GND
9	NC	10	GND
11	NC	12	DDC Date
13	H-SYNC	14	V-SYNC
15	DDC Clock		

Note! VGA does not support hot plug function due to Intel's constraint



2.4.5 USB Connectors

The ARK-1123C provides three USB interface connectors - 2 x USB 2.0 & 1 x USB 3.0, which give complete Plug & Play. The USB interface is compliant with USB UHCI, Rev. 2.0 & 3.0. The USB interface supports Plug and Play, which enables you to connect or disconnect a device whenever you want, without turning off the computer.

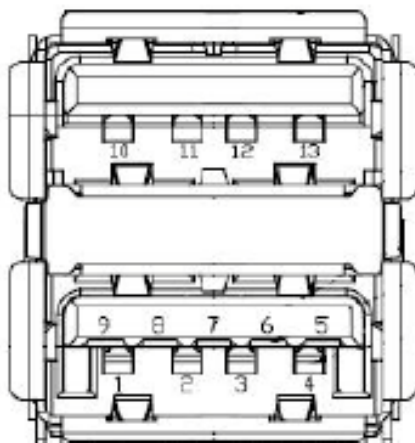

Figure 2.18 USB Connector

Table 2.10: USB Connector Pin Assignments

Pin	Signal Name	Pin	Signal Name
1	+5V	2	D-
3	D+	4	GND
5	SSRX-	6	SSRX+
7	GND	8	SSTX-
9	SSTX+	10	+5V
11	D-	12	D+
13	GND		

2.4.6 Audio Connector

ARK-1123C offers stereo audio ports by two 3.5 ear phone jack connectors of Line_out and Line_in. The audio chip controller is ALC-888S which is compliant with the Azalea standard.

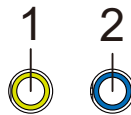

Figure 2.19 Audio Connector

Table 2.11: Audio Connector Pin Assignments

Pin	Signal Name
1	Line-out
2	Line-in

2.4.7 COM Connector

ARK-1123C provides two D-sub 9-pin connectors, which offers RS-232/422/485 (BIOS Selectable) serial communication interface.

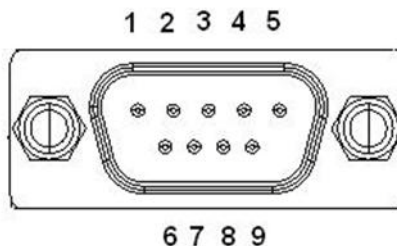

Figure 2.20 COM Port Connector

Table 2.12: COM Connector Pin Assignments

	RS-232	RS-422	RS-485
Pin	Signal Name	Signal Name	Signal Name
1	DCD	Tx-	DATA-
2	RxD	Tx+	DATA+
3	TxD	Rx+	NC
4	DTR	Rx-	NC

5	GND	GND	GND
6	DSR	NC	NC
7	RTS	NC	NC
8	CTS	NC	NC
9	RI	NC	NC

Note! NC means “No Connection”.



2.4.8 HDD LED Indicator

HDD LED indicator on ARK-1123C front metal face plate for indicating system status: HDD LED is for HDD flash disk status.



2.5 ARK-1123L External I/O Connectors

2.5.1 Power ON/OFF Button

ARK-1123L comes with a Power On/Off button with LED indicators on the front side to show its On status (Green LED) and Off/Suspend status (Orange LED). Dual functions of Soft Power -On/Off (Instant off or Delay 4 Seconds), and Suspend are supported.



Figure 2.21 Power ON/OFF Button

2.5.2 Power Input Connector

ARK-1123L comes with a DC-Jack header that carries 12 V_{DC} external power input.

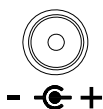

Figure 2.22 Power Input Connector

2.5.3 Ethernet Connector (LAN)

ARK-1123L provides one RJ45 LAN interface connectors which are fully compliant with IEEE 802.3u 10/100/1000 Mbps CSMA/CD standards. It is equipped with Intel I210 and support Wake on LAN. The Ethernet port uses a standard RJ-45 jack connector with LED indicators on the front side to show Active/Link status and Speed status.

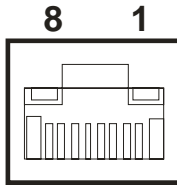

Figure 2.23 Ethernet Connector

Table 2.13: Ethernet Connector Pin Assignments	
Pin	10/100/1000 Mbps Signal Name
1	TX+, MDI0+
2	TX-, MDI0-
3	RX+, MDI1+
4	MDI2+
5	MDI2-
6	RX-, MDI1-
7	MDI3+
8	MDI3-

Note! NC, if present, means “No Connection”.



2.5.4 VGA Connector

The ARK-1123L provides a high resolution VGA interface connected by a D-sub 15-pin connector to support a VGA CRT monitor. It supports display resolution up to 2560 x 1600.

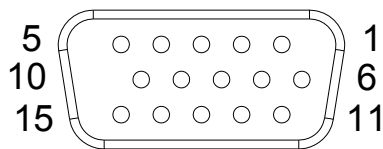

Figure 2.24 VGA Connector

Table 2.14: VGA Connector Pin Assignments			
Pin	Signal Name	Pin	Signal Name
1	Red	2	Green
3	Blue	4	NC
5	GND	6	GND
7	GND	8	GND

Table 2.14: VGA Connector Pin Assignments			
9	NC	10	GND
11	NC	12	DDC Date
13	H-SYNC	14	V-SYNC
15	DDC Clock		

Note! VGA do not support hot plug function due to Intel's constraint



2.5.5 USB Connectors

The ARK-1123L provides two USB interface connectors - 1 x USB 2.0 & 1 x USB 3.0, which give complete Plug & Play. The USB interface is compliant with USB UHCI, Rev. 2.0 & 3.0. The USB interface supports Plug and Play, which enables you to connect or disconnect a device whenever you want, without turning off the computer.

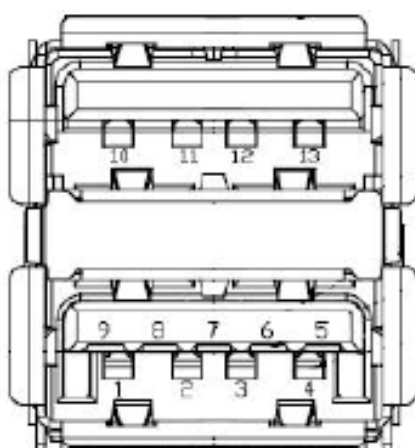

Figure 2.25 USB Connector

Table 2.15: USB Connector Pin Assignments			
Pin	Signal Name	Pin	Signal Name
1	+5V	2	D-
3	D+	4	GND
5	SSRX-	6	SSRX+
7	GND	8	SSTX-
9	SSTX+	10	+5V
11	D-	12	D+
13	GND		

2.5.6 Audio Connector

ARK-1123L offers stereo audio ports by two 3.5 ear phone jack connectors of Line_out and Line_in. The audio chip controller is ALC-888S which is compliant with the Azalea standard.

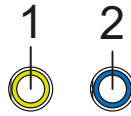

Figure 2.26 Audio Connector

Table 2.16: Audio Connector Pin Assignments

Pin	Signal Name
1	Line-out
2	Line-in

2.5.7 COM Connector

ARK-1123L provides two D-sub 9-pin connectors, which offers 1 x RS-232 & 1 x RS-232/422/485 (BIOS Selectable) serial communication interface.

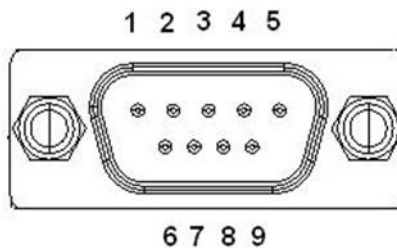

Figure 2.27 COM Port Connector

Table 2.17: COM Connector Pin Assignments

	RS-232	RS-422	RS-485
Pin	Signal Name	Signal Name	Signal Name
1	DCD	Tx-	DATA-
2	RxD	Tx+	DATA+
3	TxD	Rx+	NC
4	DTR	Rx-	NC
5	GND	GND	GND
6	DSR	NC	NC
7	RTS	NC	NC
8	CTS	NC	NC
9	RI	NC	NC

Note! NC means “No Connection”.



2.5.8 DIO Connector

ARK-1123L offers an 8-bit DIO connector and one ground pin. Each bit of DIO can be set as digital input or output independently. The direction of each bit can be set via Advantech SUSI utility.

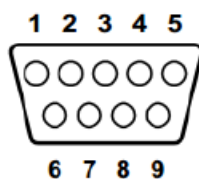

Table 2.18: DIO Connector Pin Assignments

Pin	Signal Name
1	DIO bit0
2	DIO bit1
3	DIO bit2
4	DIO bit3
5	DIO bit4
6	DIO bit5
7	DIO bit6
8	DIO bit7
9	GND

2.5.9 HDD LED Indicator

HDD LED indicator on ARK-1123L front metal face plate for indicating system status: HDD LED is for HDD flash disk status.



2.6 Peripheral Installation

2.6.1 HDD Installation

1. Unscrew the bottom cover screws. (marked with "HDD")



2. Remove the four snap rivets from the bottom cover.

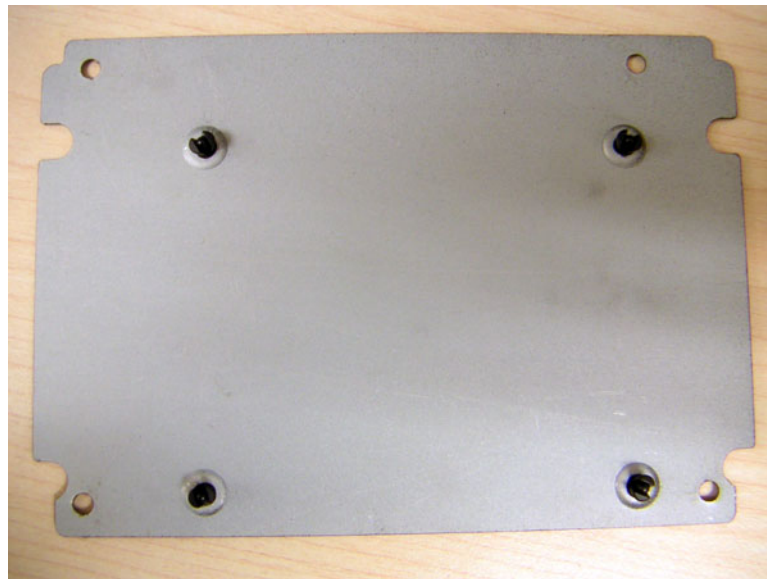

- Secure 2.5" SATA HDD onto the bottom cover. The screws are in the accessory box.



- Connect SATA signal and power cable to the 2.5" SATA HDD.



- Secure the bottom cover in its original position.



2.6.2 mSATA HD Installation

**** Below installation is for ARK-1123L only. For ARK-1123H & ARK-1123C, we suggest to install by CTOS due to complex installation with H/S mSATA.**

1. Unscrew the bottom cover screws (Marked "HDD").



2. Insert mSATA storage into the slot and secure the screw to fix the mSATA storage.



- Secure the original screw.



2.6.3 RAM Installation

- Unscrew the four screws on bottom cover. (marked with "RAM")



- Unscrew the four screws on the sides of ARK-1123.



3. Unscrew the four screws on the front/rear face plate of ARK-1123.



4. Remove aluminum top chassis and install RAM.
** Please note that ARK-1123 can support DDR3L memory only.

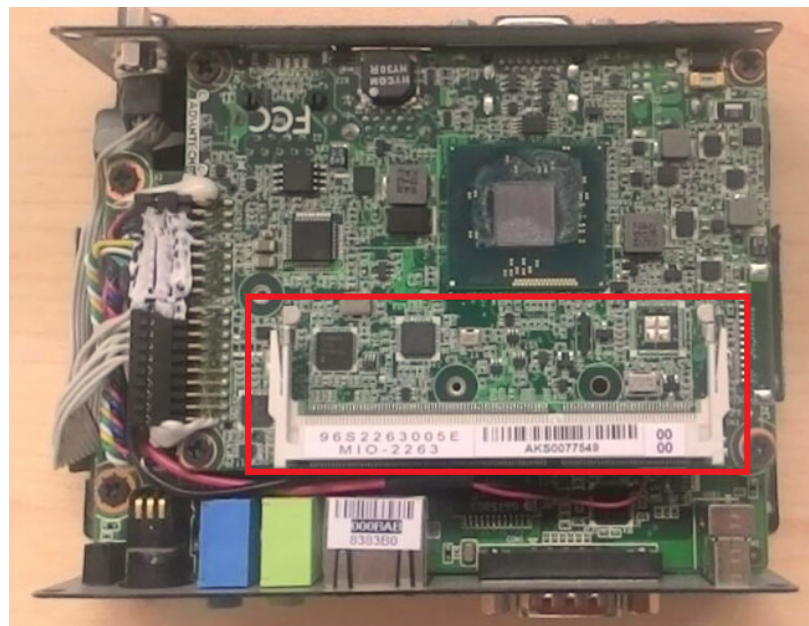

5. Replace the aluminum top chassis and secure all screws.

Chapter 3

BIOS Settings

3.1 BIOS Setup

AMIBIOS has been integrated into many motherboards for over a decade. With the AMIBIOS Setup program, users can modify BIOS settings and control various system features. This chapter describes the basic navigation of the ARK-1123 BIOS setup screens.

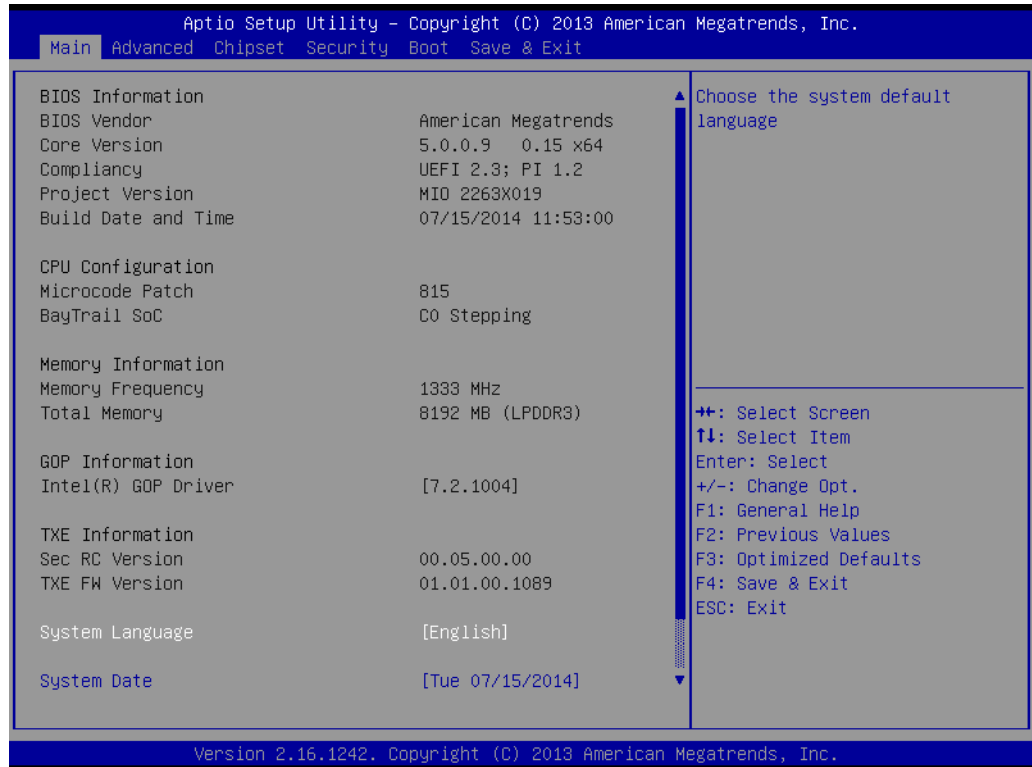

AMI's BIOS ROM has a built-in Setup program that allows users to modify the basic system configuration. This information is stored in flash ROM so it retains the Setup information when the power is turned off.

Note! *Default BIOS is supported for 64-bit OS installation, BIOS for 32-bit OS is supported by project, please contact with sales representative for details.*



3.2 Entering Setup

Turn on the computer and check for the -patch" code. If there is a number assigned to the patch code, it means that the BIOS supports your CPU. If there is no number assigned to the patch code, please contact an Advantech application engineer to obtain an up-to-date patch code file. This will ensure that your CPU's system status is valid. After ensuring that you have a number assigned to the patch code, press and you will immediately be allowed to enter Setup.

3.2.1 Main Setup

When users first enter the BIOS Setup Utility, users will enter the Main setup screen. Users can always return to the Main setup screen by selecting the Main tab. There are two Main Setup options. They are described in this section. The Main BIOS Setup screen is shown below.

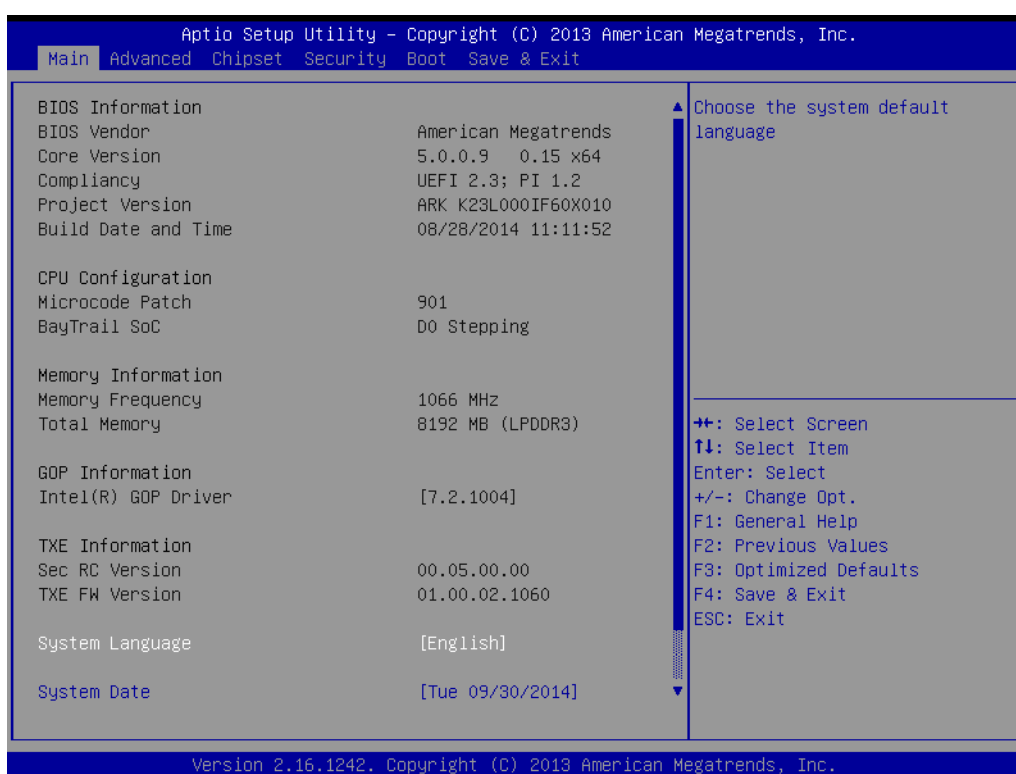

The Main BIOS setup screen has two main frames. The left frame displays all the options that can be configured. Grayed-out options cannot be configured; options in blue can. The right frame displays the key legend. Above the key legend is an area reserved for a text message. When an option is selected in the left frame, it is highlighted in white. Often a text message will accompany it.

- System time / System date

Use this option to change the system time and date. Highlight System Time or System Date using the <Arrow> keys. Enter new values through the keyboard. Press the <Tab> key or the <Arrow> keys to move between fields. The date must be entered in MM/DD/YY format. The time must be entered in HH:MM:SS format.

3.2.2 Advanced BIOS Features Setup

Select the Advanced tab from the ARK-1123 setup screen to enter the Advanced BIOS Setup screen. Users can select any item in the left frame of the screen, such as CPU Configuration, to go to the sub menu for that item. Users can display an Advanced BIOS Setup option by highlighting it using the <Arrow> keys. All Advanced BIOS Setup options are described in this section. The Advanced BIOS Setup screens are shown below. The sub menus are described on the following pages.

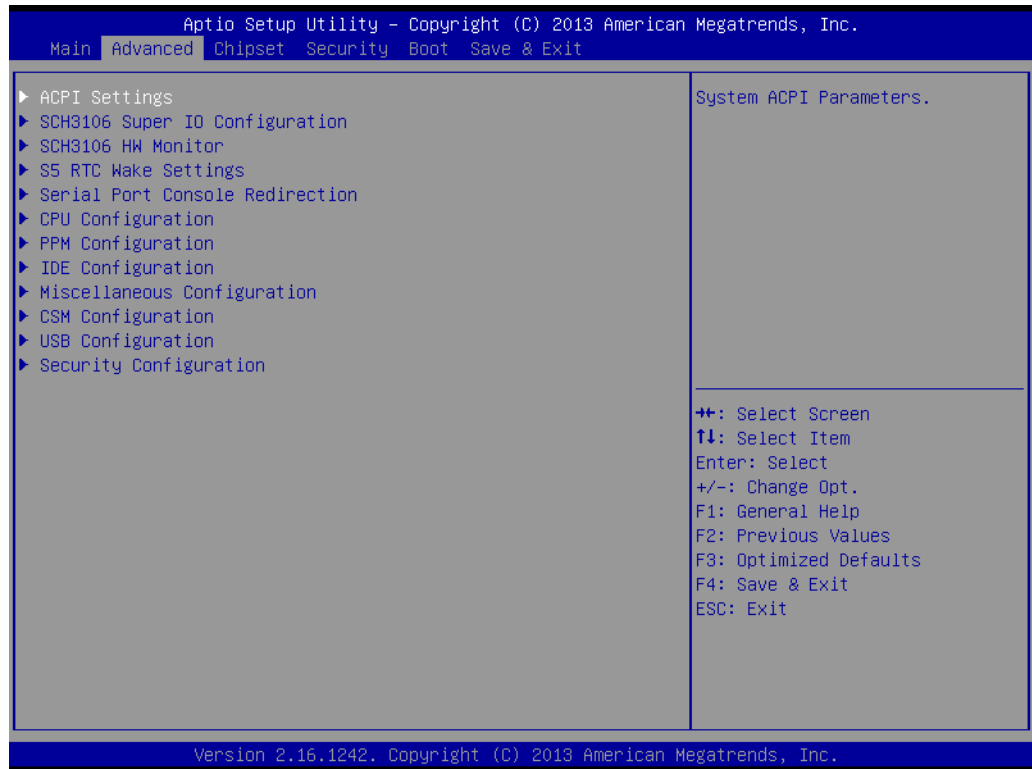

3.2.2.1 ACPI Settings Configuration



- **Enable ACPI Auto Configuration**
Enable or disable BIOS ACPI auto configuration.
- **Enable Hibernation**
Enables or Disables System ability to Hibernate (OS/S4 Sleep State). This option may be not effective with some OS.
- **ACPI Sleep State**
Select the highest ACPI sleep state the system will enter when the SUSPEND button is pressed.
- **Lock Legacy Resources**
Enables or Disables Lock of Legacy Resources

3.2.2.2 Super I/O Configuration

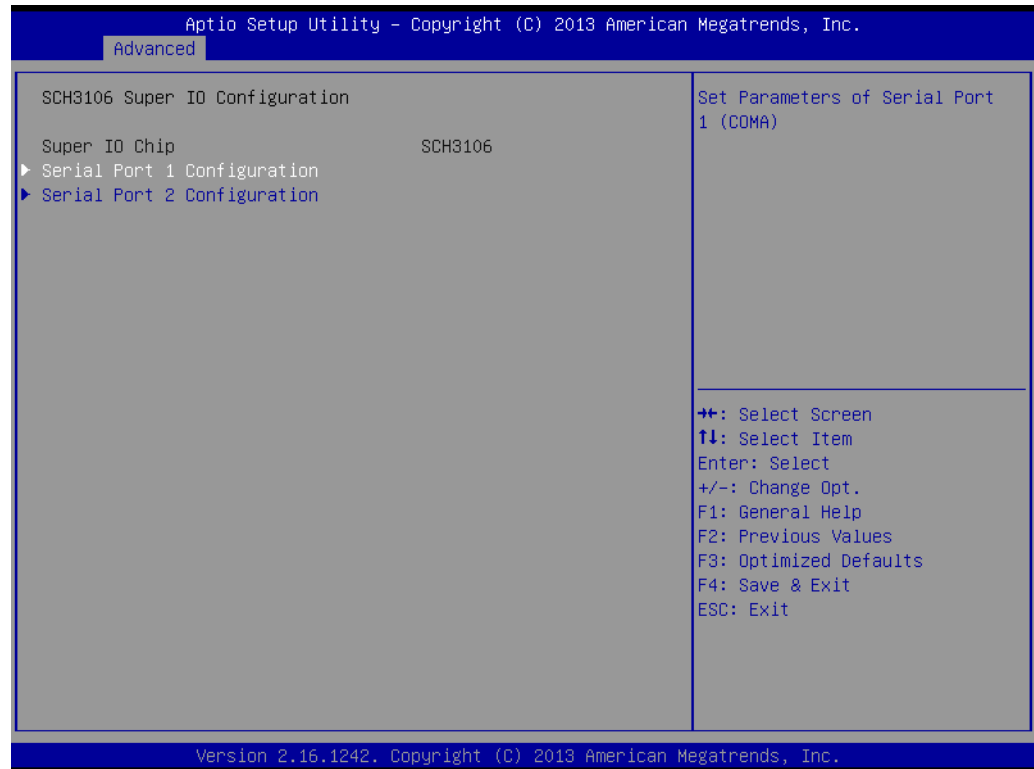

- Serial Port 1 Configuration
Set Parameters of Serial Port 1
- Serial Port 2 Configuration
Set Parameters of Serial Port 2

3.2.2.3 H/W Monitor

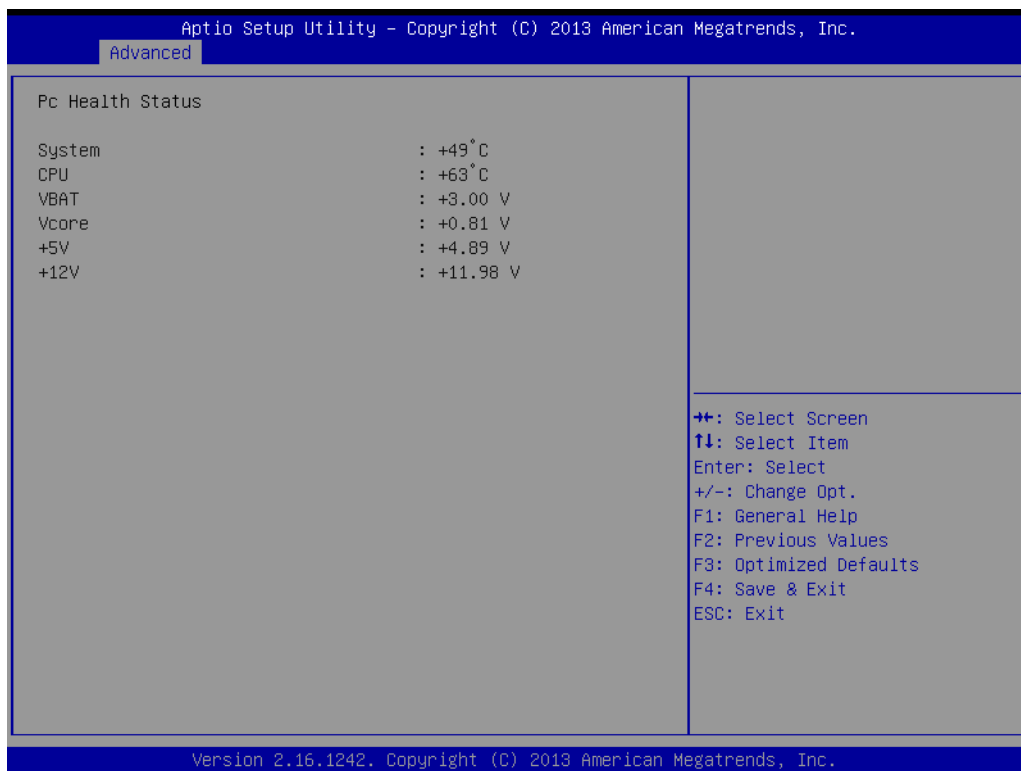

- **Pc Health Status**
This page display all information about system Temperature/Voltage.

3.2.2.4 S5 RTC Wake Settings



- **Wake system with Fixed Time**
Enable or disable System wake on alarm event. Select FixedTime, system will wake on the hr:min:sec specified. Select DynamicTime, System will wake on the current time + Increase minute(s).

3.2.2.5 Serial Port Console Redirection

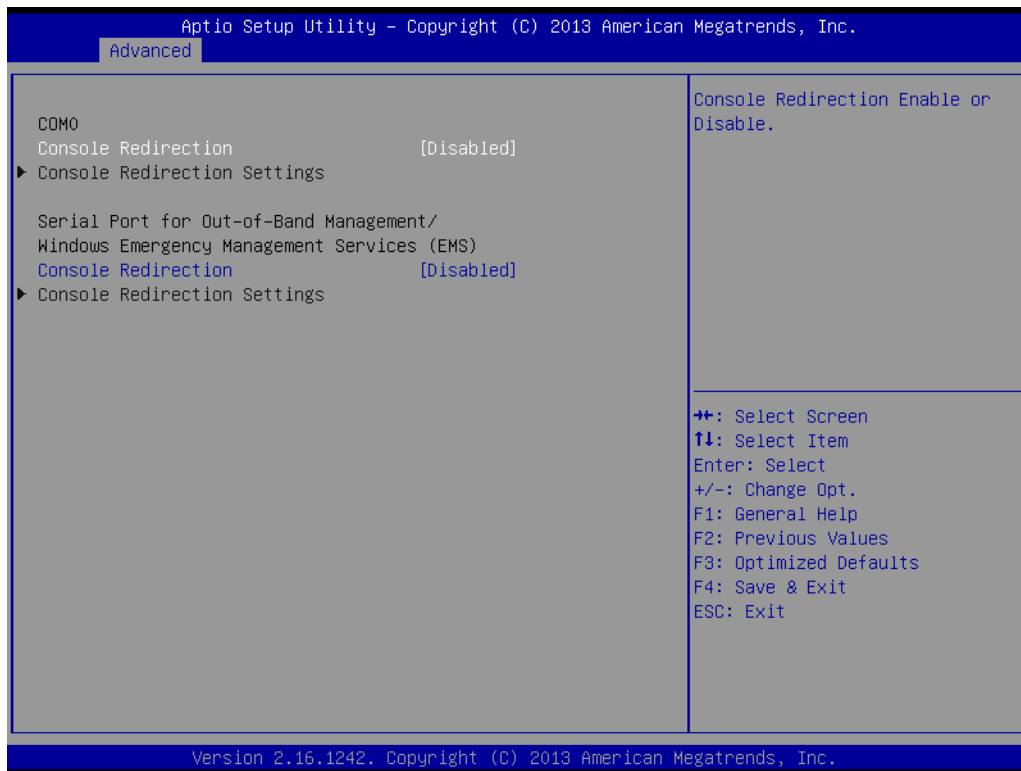

- **Console Redirection**
This item allows users to enable or disable console redirection for Microsoft Windows Emergency Management Services (EMS).
- **Console Redirection**
This item allows users to configuration console redirection detail settings.

3.2.2.6 CPU Configuration



- PPS Support
This item allows you to enable or disable the ACPI _PPC, _PSS, and _PCT objects.
- Limit CPUID Maximum
Disabled for Windows XP
- Execute Disable Bit
XD can prevent certain classes of malicious buffer overflow attacks when combined with a supporting OS (Windows Server 2003 SP1, Windows XP SP2, SuSE Linux 9.2, RedHat Enterprise 3 Update 3.)
- Intel Virtualization Technology
When enabled, a VMM can utilize the additional hardware capabilities provided by Vanderpool Technology.
- Power Technology
Enable the power management features.

3.2.2.7 PPM Configuration

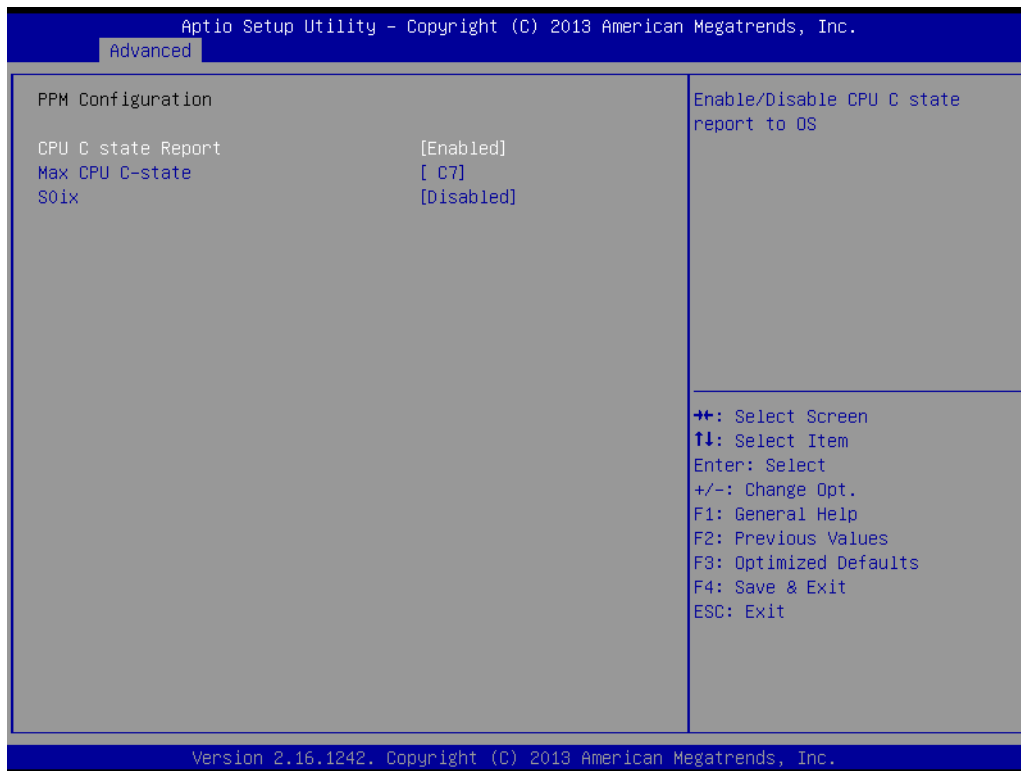

- CPU C state Report
Enable/Disable CPU C state report to OS
- Max CPU C-state
This option controls Max C state that the processor will support
- S0ix
Enable/Disable CPU S0ix state

3.2.2.8 IDE Configuration

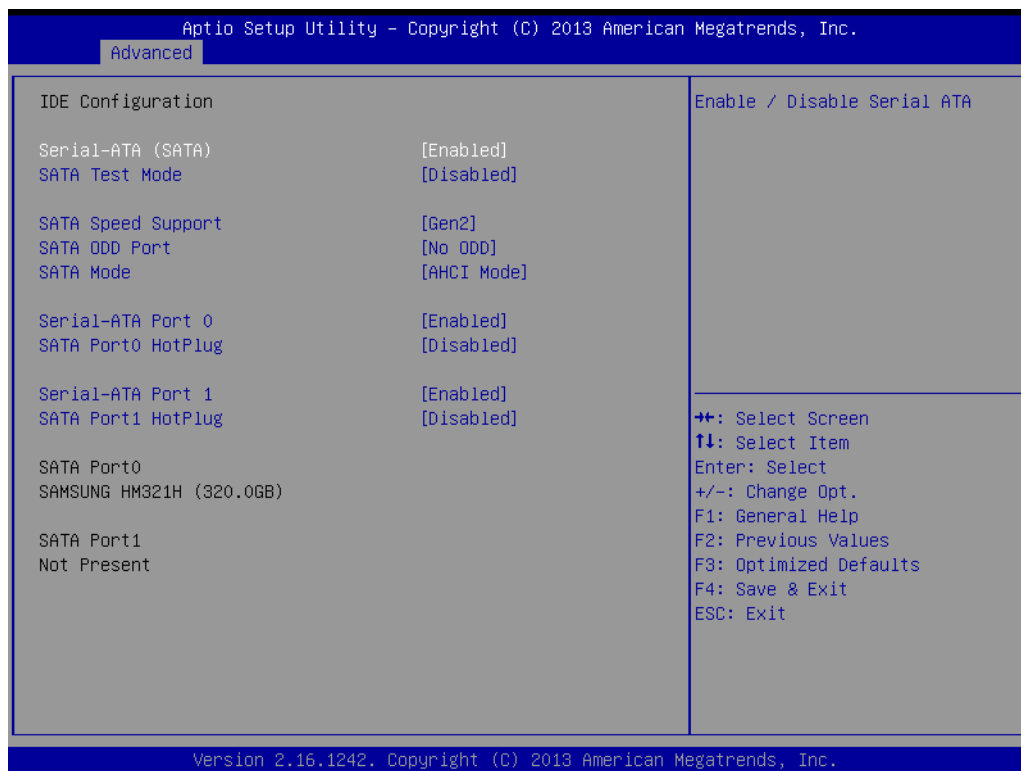

- Serial-ATA (SATA)
Enable / Disable Serial ATA
- SATA Test Mode
Test Mode Enable / Disable.
- SATA Speed Support
SATA Speed Support Gen1 or Gen2
- SATA ODD Port
SATA ODD is Port0 or Port1
- SATA Mode
Select IDE / AHCI
- Serial-ATA Port 0
Enable / Disable Serial ATA Port 0

3.2.2.9 Miscellaneous Configuration

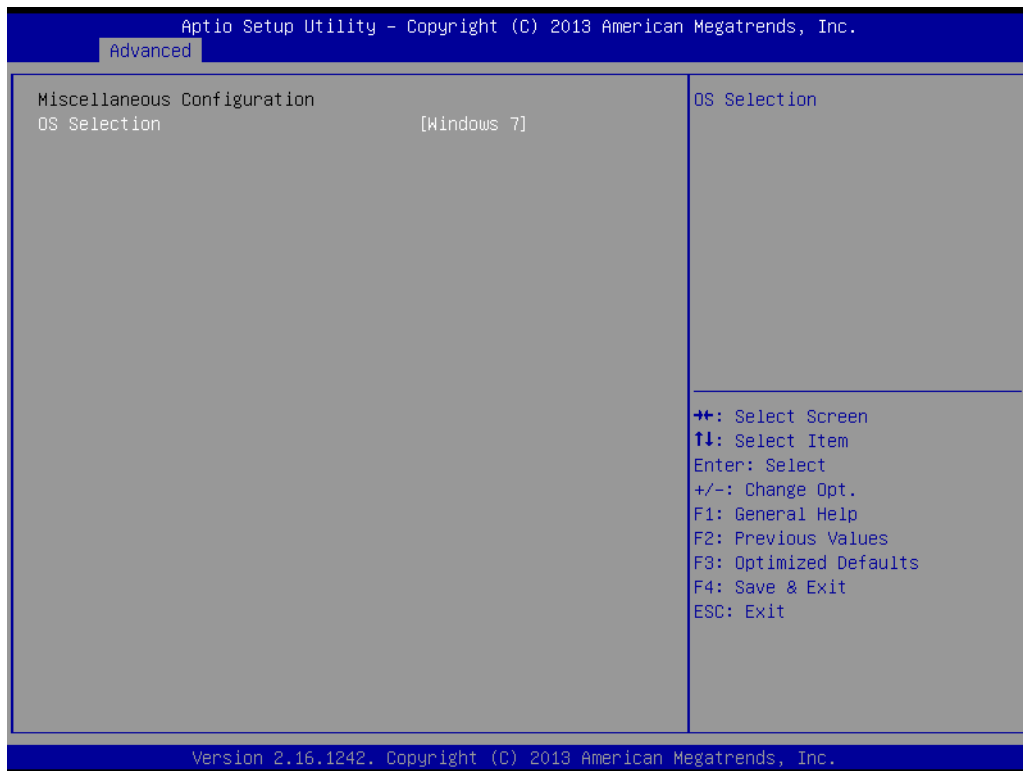

- OS Selection
OS Selection to choose Windows 8.X / Windows 7

3.2.2.10 CSM Configuration



- CSM Support
Enable/Disable CSM Support.
- GateA20 Active
UPON REQUEST - GA20 can be disabled using BIOS services. ALWAYS - do not allow disabling GA20; this option is useful when any RT code is executed above 1 MB.
- Option ROM Messages
Set display mode for Option ROM
- INT19 Trap Response
BIOS reaction on INT19 trapping by Option ROM: IMMEDIATE - execute the trap right away; POSTPONED - execute the trap during legacy boot.
- Boot option filter
This option controls Legacy/UEFI ROMs priority
- Network
Controls the execution of UEFI and Legacy PXE OpROM
- Storage
Controls the execution of UEFI and Legacy Storage OpROM
- Video
Controls the execution of UEFI and Legacy Video OpROM
- Other PCI devices
Determines OpROM execution policy for devices other than Network, Storage, or Video

3.2.2.11 USB Configuration



- **Legacy USB Support**
Enables support for legacy USB. Auto option disables legacy support if no USB devices are connected. DISABLE option will keep USB devices available only for EFI applications.
- **XHCI Hand-Off**
This is a workaround for OS without XHCI hand-off support. The XHCI ownership change should claim by XHCI driver.
- **EHCI Hand-Off**
This is a workaround for OS without EHCI hand-off support. The EHCI ownership change should claim by EHCI driver.
- **USB Mass Storage Driver Support**
This item allows you to enable or disable the USB mass storage device support.
- **Device reset time-out**
USB mass storage device start unit command time-out.
- **Device power-up delay**
Maximum time the device will take before it properly report itself to the host controller. "Auto" uses default value: for a Root port it is 100 ms, for a Hub port the delay is taken from Hub descriptor.

3.2.2.12 Security Configuration

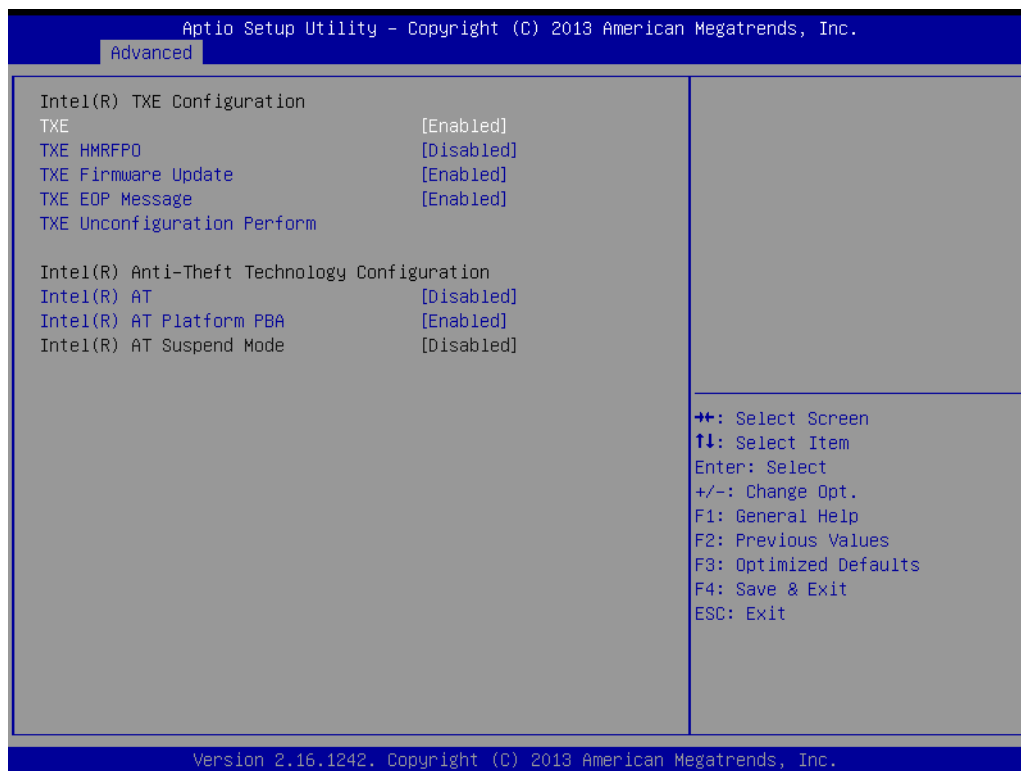

- SMART Self Test
This item allows you to enable or disable the SMART self test function.
- TXE
- TXE HMRFPD Disable
- TXE Firmware Update
- TXE EOP Message
Send EOP Message Before Entering OS
- TXE Unconfiguration Perform
Revert TXE settings to factory defaults
- Intel(R) AT
Enable/Disable BIOS AT Code from Running
- Intel(R) AT Platform PBA
Enable/Disable BIOS AT Code from Running

3.2.3 Chipset Configuration

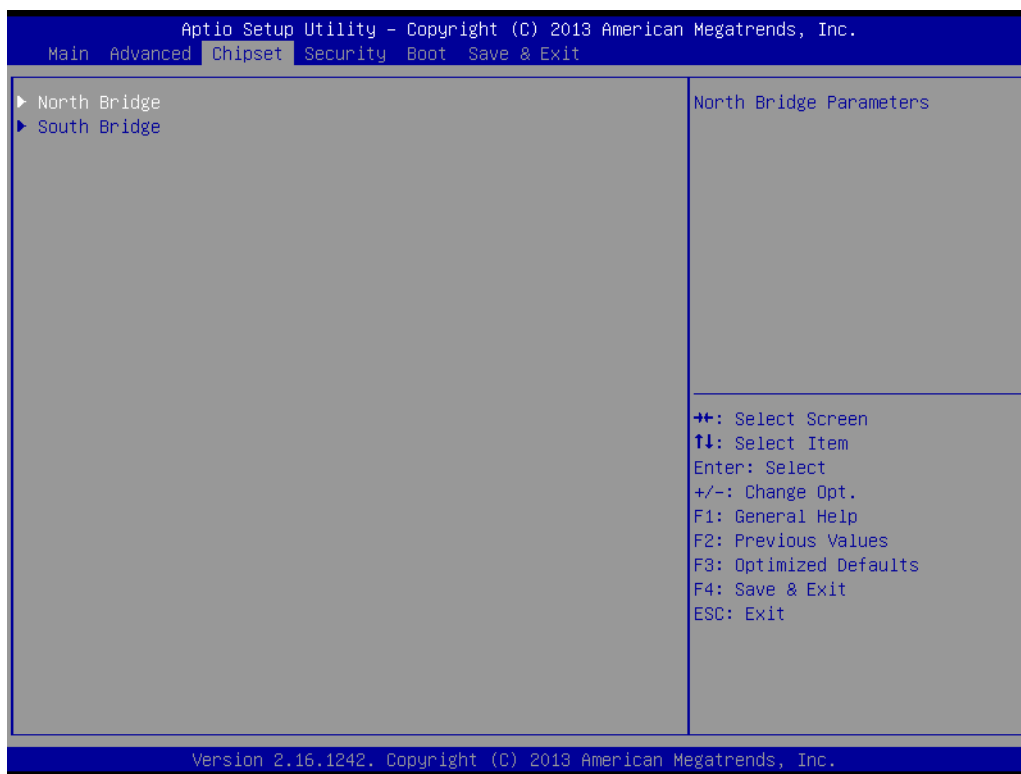

- North Bridge
Detail for North Bridge items.
- South Bridge
Detail for South Bridge items.

3.2.3.1 North Bridge

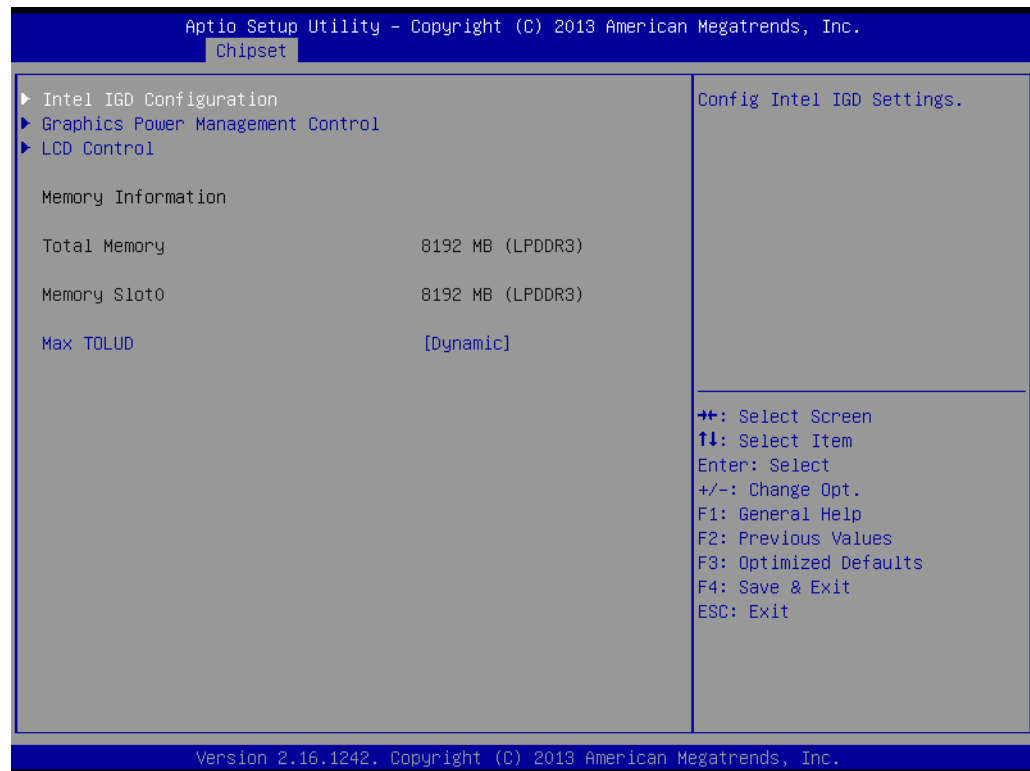

- Intel IGD Configuration
Config Intel IGD Settings.
- Graphics Power Management Control
Graphics Power Management Control Options
- LCD Control
LCD Control
- Max TOLUD
Maximum Value of TOLUD

3.2.3.2 Intel IGD Configuration

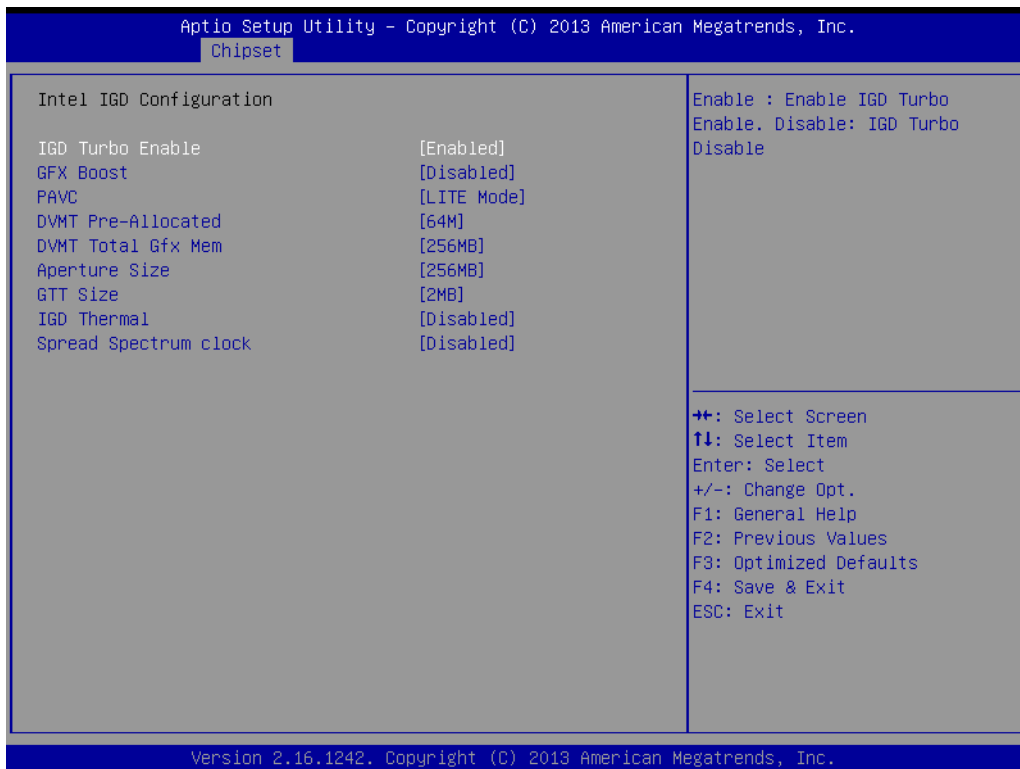

- Intel IGD Configuration
Config Intel IGD Settings.
- IGD Turbo Enable
Enable: Enable IGD Turbo Enable. Disable: IGD Turbo Disable
- GFX Boost
Enable/Disable GFX Boost
- PAVC
Enable/Disable Protected Audio Video Control
- DVMT Pre-Allocated
Select DVMT 5.0 Pre-Allocated (Fixed) Graphics Memory size used by the Internal Graphics Device.
- DVMT Total Gfx Mem
Select DVMT 5.0 Total Graphic Memory size used by the Internal Graphics Device.
- Aperture Size
Select the Aperture Size
- GTT Size
Select the GTT Size
- IGD Thermal
Enable/Disable IGD Thermal
- Spread Spectrum clock
Enable/Disable Spread Spectrum clock

3.2.3.3 Graphics Power Management Control

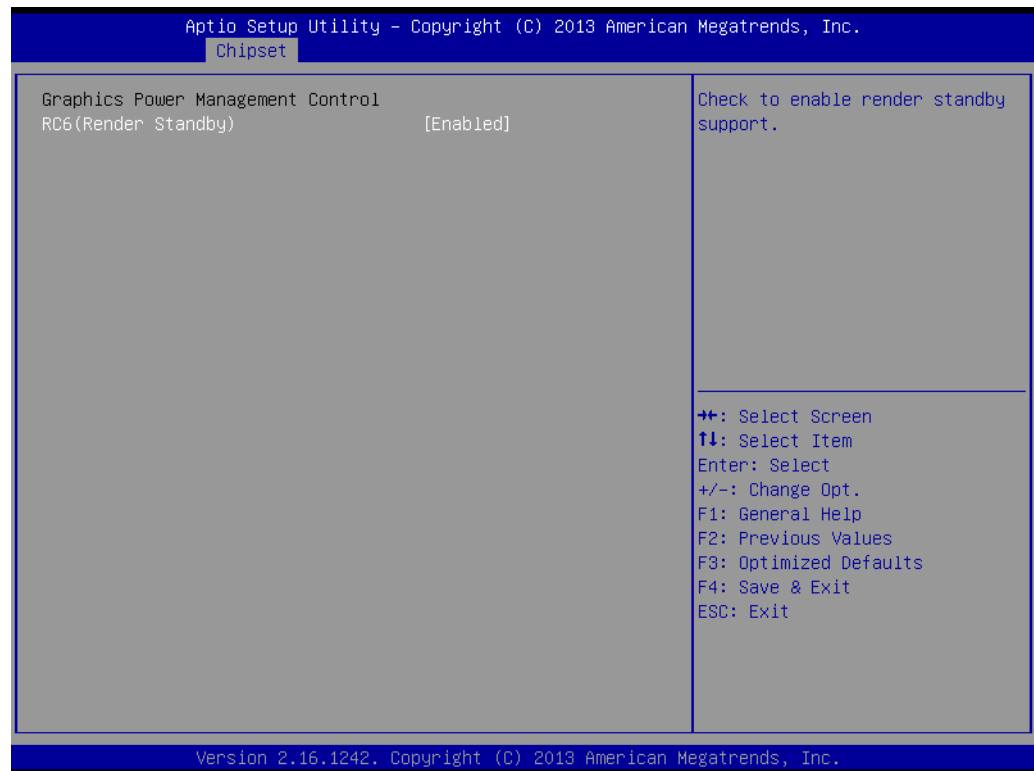

- RC6 (Render Standby)
Check to enable render standby support.

3.2.3.4 LCD Control



- **Primary IGFX Boot Display**
 Select the Video Device which will be activated during POST.
 This has no effect if external graphics present.
 Secondary boot display selection will appear based on your selection.
 VGA modes will be supported only on primary display

3.2.3.5 South Bridge

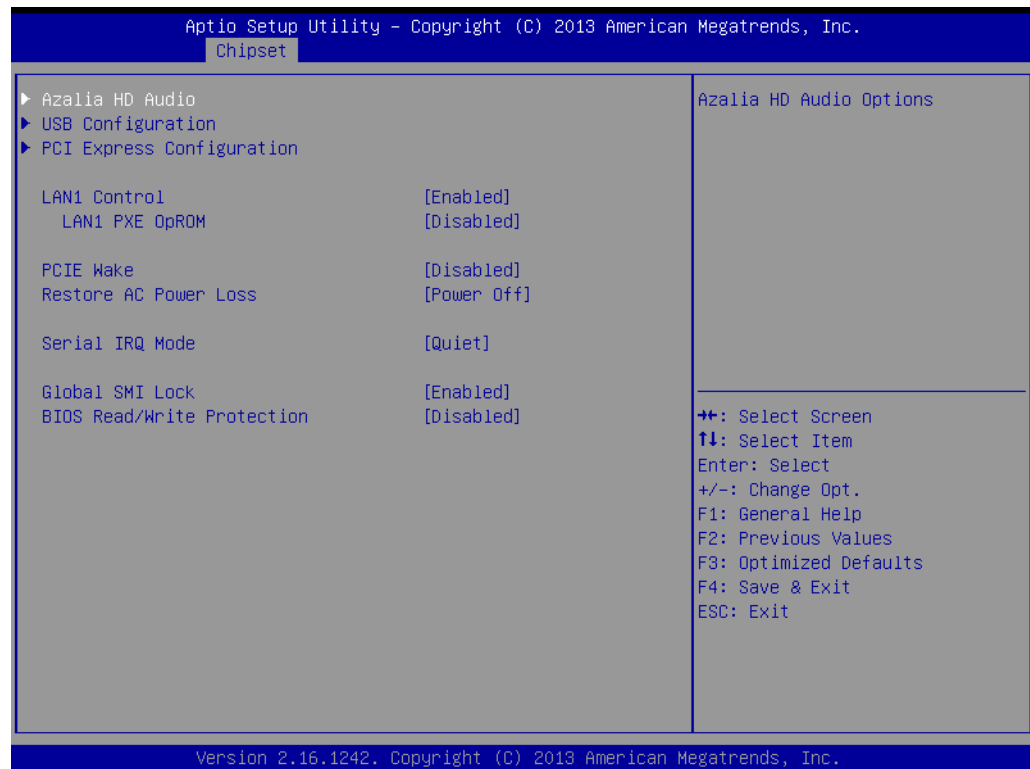

- SB SATA Configuration
Options for SATA configuration.
- SB USB Configuration
Options for SB USB configuration.
- SB HD Azalia Configuration
Options for SB HD Azalia.
- PCI-E Port
Options for PCI-E devices control.
- Restore on AC Power Loss
This item allows you to select system restore states if AC power loss.
- Azalia HD Audio
Azalia HD Audio Options
- USB Configuration
USB Configuration Settings
- PCI Express Configuration
PCI Express Configuration settings
- LAN1 Control
Enable or Disable the LAN1.
- LAN1 PXE OpROM
Enable or Disable boot option for LAN1 Controller.
- PCIE Wake
Enable or Disable PCIE to wake the system from S5.
- Restore AC Power Loss
Select AC power state when power is re-applied after a power failure.
- Serial IRQ Mode

- Configure Serial IRQ Mode.
- Global SMI Lock
Enable or Disable SMI lock.
- BIOS Read/Write Protection
Enable or Disable BIOS SPI region read/write protect.

3.2.3.6 Azalia HD Audio

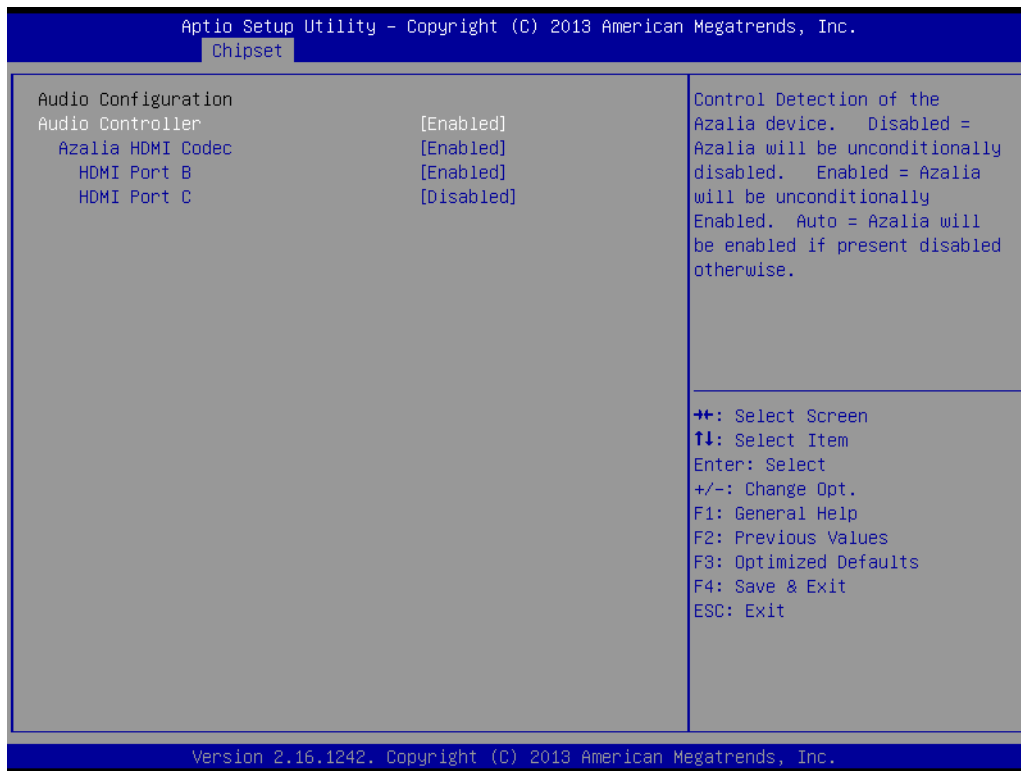

- Audio Controller
Control Detection of the Azalia device. Disabled = Azalia will be unconditionally disabled. Enabled = Azalia will be unconditionally Enabled. Auto = Azalia will be enabled if present disabled otherwise.
- Azalia HDMI Codec
Enable/Disable internal HDMI codec for Azalia
- HDMI Port B
Enable/Disable HDMI Port B
- HDMI Port C
Enable/Disable HDMI Port C

3.2.3.7 USB Configuration

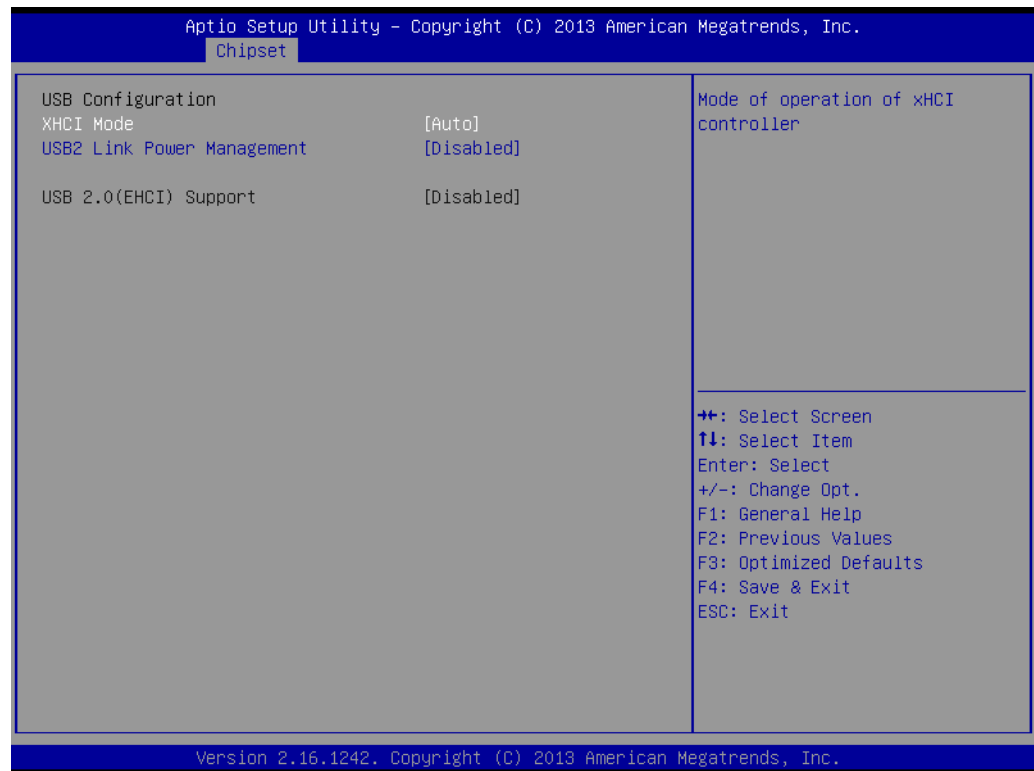

- XHCI Mode
Mode of operation of xHCI controller
- USB2 Link Power Management
Enable/Disable USB2 Link Power Management.
- USB 2.0(EHCI) Support
Control the USB EHCI (USB 2.0) functions. One EHCI controller must always be enabled

3.2.3.8 PCI Express Configuration

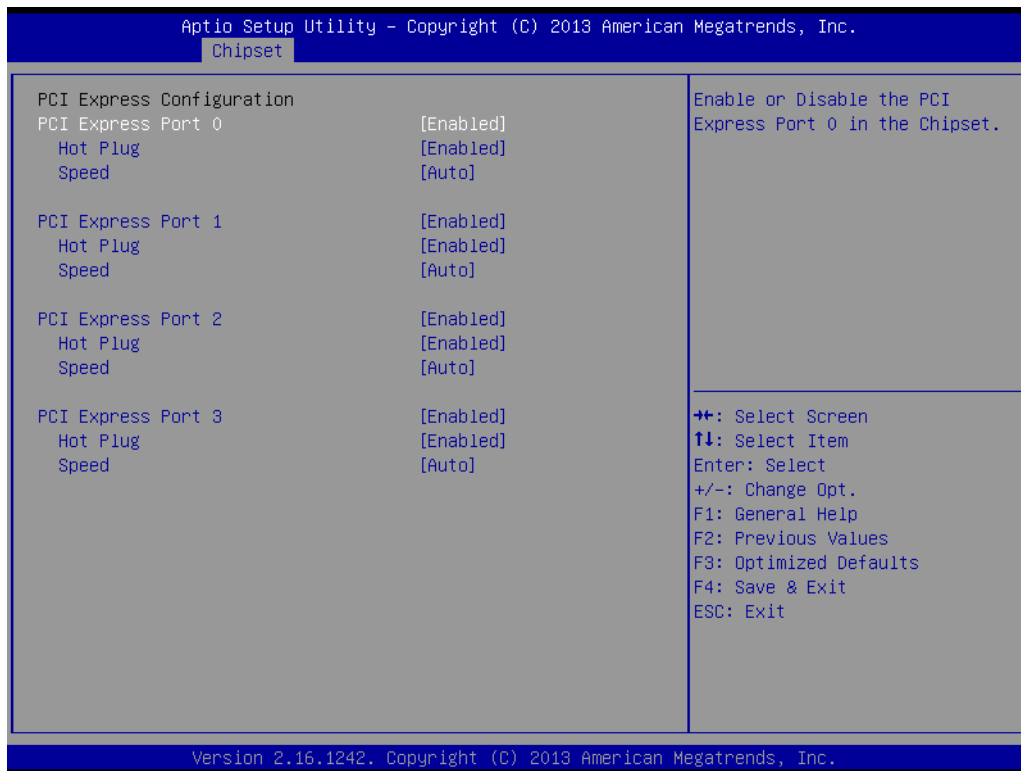

- PCI Express Port 0
Enable or Disable the PCI Express Port 0 in the Chipset.
- Hot Plug
Enable or disable PCI Express Hot Plug.
- Speed
Configure PCIe Port Speed

3.2.4 Security

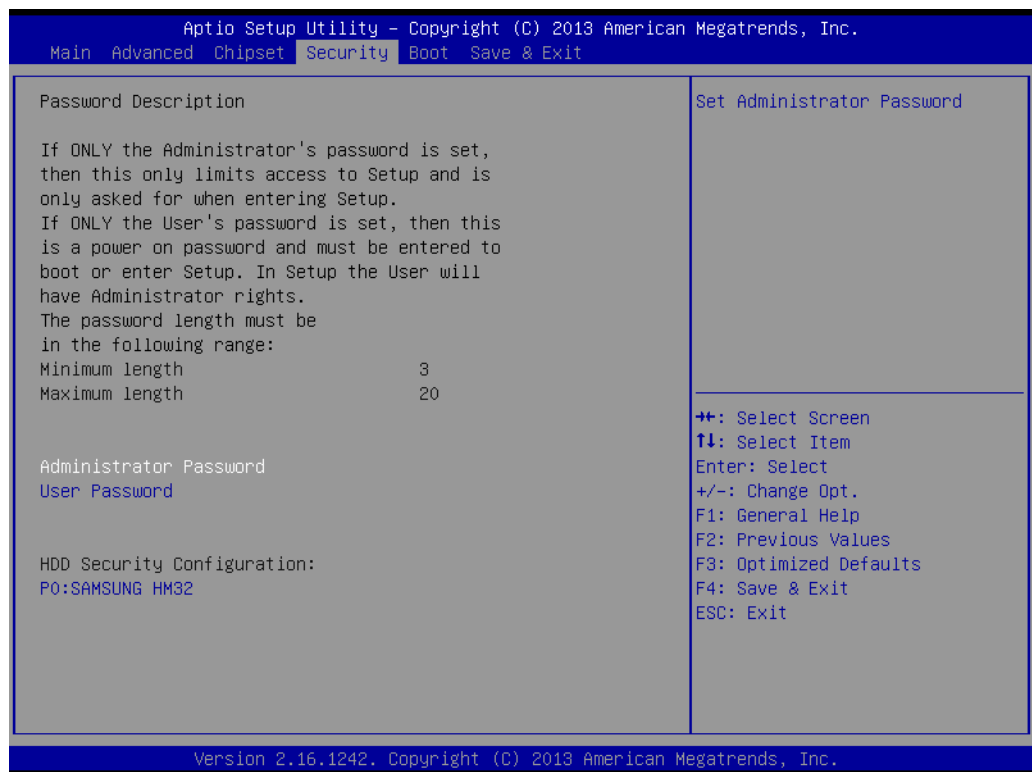

Select Security Setup from the ARK-1123 Setup main BIOS setup menu. All Security Setup options, such as password protection and virus protection are described in this section. To access the sub menu for the following items, select the item and press <Enter>:

- Change Administrator / User Password

3.2.5 Boot

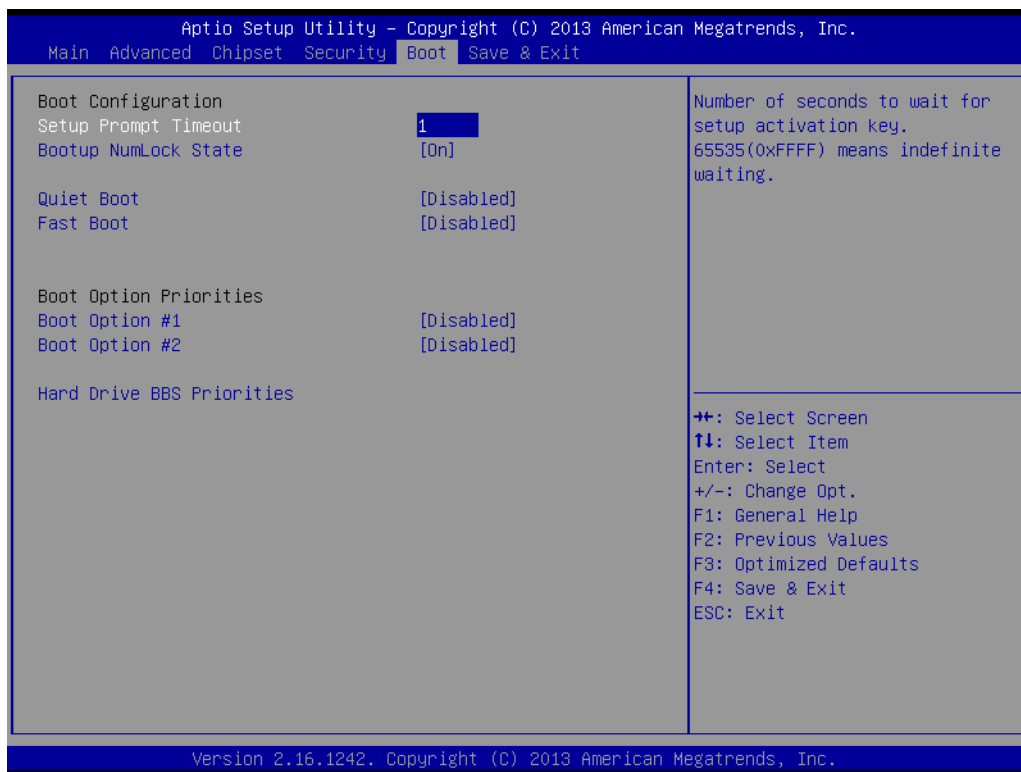

- **Setup Prompt Timeout**
Number of seconds that the firmware will wait before initiating the original default boot selection. A value of 0 indicates that the default boot selection is to be initiated immediately on boot. A value of 65535(0xFFFF) indicates that firmware will wait for user input before booting. This means the default boot selection is not automatically started by the firmware.
- **Bootup NumLock State**
Select the keyboard NumLock state
- **Quiet Boot**
Enables or disables Quiet Boot option
- **Fast Boot**
Enables or disables boot with initialization of a minimal set of devices required to launch active boot option. Has no effect for BBS boot options.
- **Boot Option #1**
Sets the system boot order

3.2.6 Save & Exit

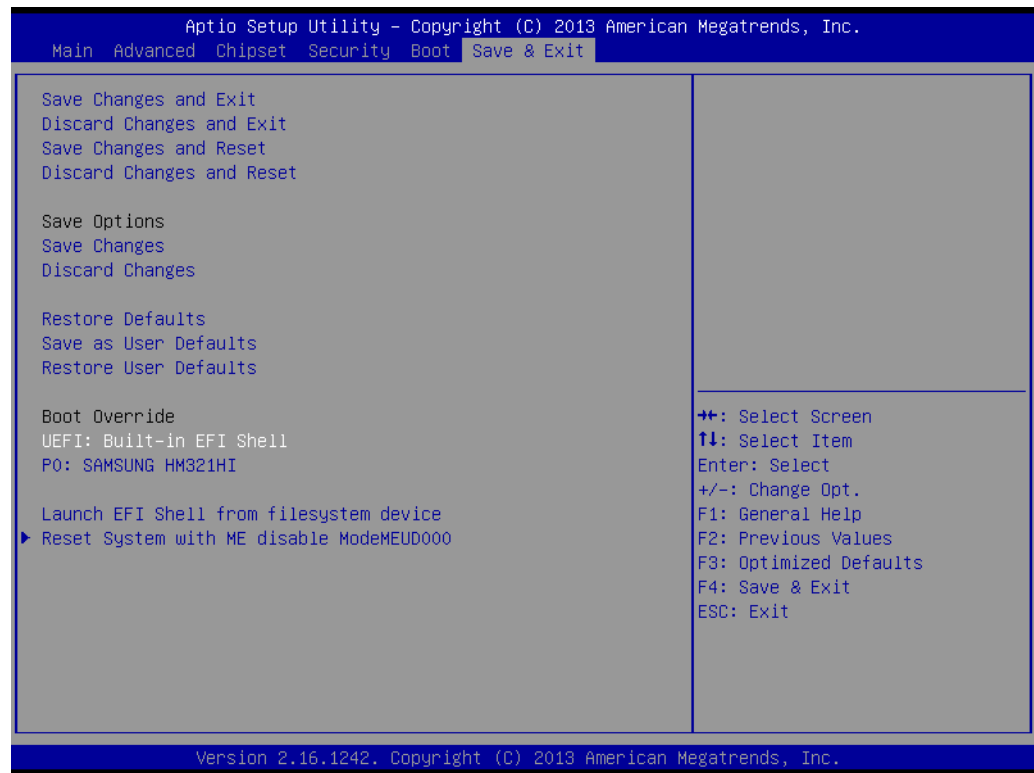

- Save Changes and Exit
This item allows you to exit system setup after saving the changes.
- Discard Changes and Exit
This item allows you to exit system setup without saving any changes.
- Save Changes and Reset
This item allows you to reset the system after saving the changes.
- Discard Changes and Reset
This item allows you to rest system setup without saving any changes.
- Save Changes
This item allows you to save changes done so far to any of the options.
- Discard Changes
This item allows you to discard changes done so far to any of the options.
- Restore Defaults
This item allows you to restore/load default values for all the options.
- Save as User Defaults
This item allows you to save the changes done so far as user defaults.
- Restore User Defaults
This item allows you to restore the user defaults to all the options.
- Boot Override
Boot device select can override your boot priority.

Appendix **A**

WDT & GPIO Sample
Code

A.1 Watchdog Timer Sample Code

Watchdog function:

```
;The SCH3114 Runtime base I/O address is A00h
;Setting WatchDog time value location at offset 66h
;If set value "0", it is mean disable WatchDog function.
Superio_GPIO_Port = A00h
mov dx,Superio_GPIO_Port + 66h
mov al,00h
out dx,al
.model small
.486p
.stack 256
.data
SCH3114_IO EQU A00h
.code
org 100h
.STARTup
;=====
;47H
;enable WDT function bit [0]=0Ch
;=====
mov dx,SCH3114_IO + 47h
mov al,0Ch
out dx,al
;=====
;65H
;bit [1:0]=Reserved
;bit [6:2]Reserve=00000
;bit [7] WDT time-out Value Units Select
;Minutes=0 (default) Seconds=1
;=====
mov dx,SCH3114_IO + 65h ;
mov al,080h
out dx,al
;=====
;66H
;WDT timer time-out value
;bit[7:0]=0~255
;=====
mov dx,SCH3114_IO + 66h
mov al,01h
out dx,al
;=====
;bit[0] status bit R/W
;WD timeout occurred =1
```

```
;WD timer counting = 0  
;=====  
mov dx,SCH3114_IO + 68h  
mov al,01h  
out dx,al  
.exit  
END
```

ADVANTECH

Enabling an Intelligent Planet

www.advantech.com

Please verify specifications before quoting. This guide is intended for reference purpOS only.

All product specifications are subject to change without notice.

No part of this publication may be reproduced in any form or by any means, electronic, photocopying, recording or otherwise, without prior written permission of the publisher.

All brand and product names are trademarks or registered trademarks of their respective companies.

© Advantech Co., Ltd. 2014